

158S 端面溝入れ 3-4mm

R158S
正回転用

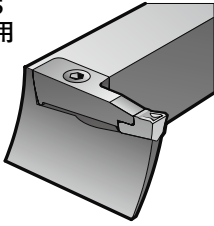

L158S
逆回転用

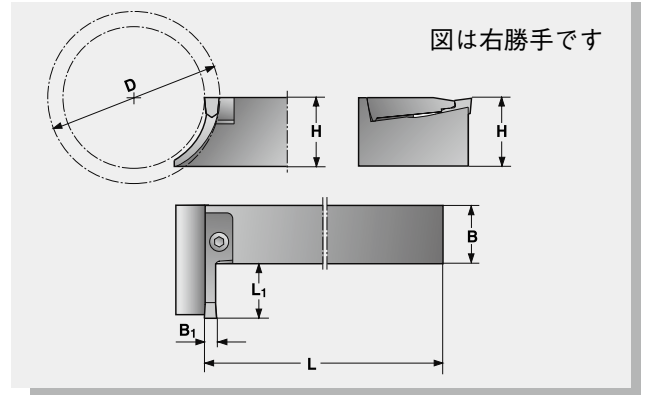
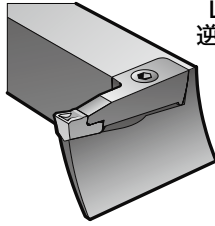

適用チップ	型番	在庫	単価		寸法 (mm)					クランプ		クランプ スクリュー	スプリング	レンチ		
			R 右勝手	L 左勝手	H	B	L	L1	B1	D	L158S用 SHR	R158S用 SHL				
チップ幅 3.0 (3.2) mm 端面径φ 20mm 以上																
※	R/L 158S-1616 × 12 × 3/20-23		62,680	68,960						20-23	※) SHR 133Z	※) SHL 133Z	F6S-411	—	NY 2.5	
※	R/L 158S-1616 × 12 × 3/23-26		62,680	68,960					23-26							
※	R/L 158S-1616 × 12 × 3/26-30		62,680	68,960					26-30							
	R/L 158S-1616 × 12 × 3/30-35		62,680	68,960	16	16	110	12	3	30-35	※) SHR 133P	※) SHL 133P				
	R/L 158S-1616 × 12 × 3/35-40		62,680	68,960					35-40							
	R/L 158S-1616 × 12 × 3/40-50		62,680	68,960					40-50	※) SHR 133	※) SHL 133					
※	R/L 158S-2020 × 12 × 3/20-23	○	62,680	68,960						20-23	※) SHR 133Z	※) SHL 133Z	F6S-411	—	NY 2.5	
※	R/L 158S-2020 × 12 × 3/23-26			62,680	68,960					23-26						
※	R/L 158S-2020 × 12 × 3/26-30			62,680	68,960					26-30						
	R/L 158S-2020 × 12 × 3/30-35			62,680	68,960					30-35	※) SHR 133P	※) SHL 133P				
	R/L 158S-2020 × 12 × 3/35-40			62,680	68,960					35-40						
	R/L 158S-2020 × 12 × 3/40-50			62,680	68,960					40-50						
	R/L 158S-2020 × 12 × 3/50-60T			62,680	68,960					50-60						
	R/L 158S-2020 × 12 × 3/60-75T			62,680	68,960					60-75						
	R/L 158S-2020 × 12 × 3/75-100T			62,680	68,960	20	20	125	12	3	75-100	※) SHR 133				※) SHL 133
	R/L 158S-2020 × 12 × 3/100-140T			62,680	68,960					100-140						
	R/L 158S-2020 × 12 × 3/140-190T		62,680	68,960					140-190							
	R/L 158S-2020 × 12 × 3/190-300T		62,680	68,960					190-300							
3	R/L 158S-2020 × 12 × 3/300-500T		62,680	68,960					300-500							
	R/L 158S-2020 × 12 × 3/500-∞ T		62,680	68,960					500-∞							
※	R/L 158S-2525 × 12 × 3/20-23	○	64,850	71,370						20-23	※) SHR 133Z	※) SHL 133Z	F6S-411	—	NY 2.5	
※	R/L 158S-2525 × 12 × 3/23-26	○	64,850	71,370					23-26							
※	R/L 158S-2525 × 12 × 3/26-30	○	64,850	71,370					26-30							
	R/L 158S-2525 × 12 × 3/30-35	○	64,850	71,370					30-35	※) SHR 133P	※) SHL 133P					
	R/L 158S-2525 × 12 × 3/35-40	○	64,850	71,370					35-40							
	R/L 158S-2525 × 12 × 3/40-50	○	64,850	71,370					40-50							
	R/L 158S-2525 × 12 × 3/50-60T	○	64,850	71,370					50-60							
	R/L 158S-2525 × 12 × 3/60-75T	○	64,850	71,370					60-75							
	R/L 158S-2525 × 12 × 3/75-100	○	64,850	71,370	25	25	150	12	3	75-100	※) SHR 133	※) SHL 133				
	R/L 158S-2525 × 12 × 3/100-140T	○	64,850	71,370					100-140							
	R/L 158S-2525 × 12 × 3/140-190T	○	64,850	71,370					140-190							
	R/L 158S-2525 × 12 × 3/190-300T	○	64,850	71,370					190-300							
	R/L 158S-2525 × 12 × 3/300-500T	○	64,850	71,370					300-500							
	R/L 158S-2525 × 12 × 3/500-∞ T	○	64,850	71,370					500-∞							

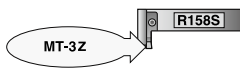

※ D 寸法 (溝外径) が、20-23、23-26、26-30 のホルダには専用チップ MT-3Z (P71) を使用してください。

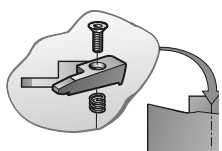

レンチ以外のパーツはホルダに付属しています。

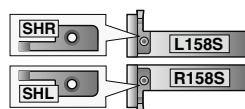

※) 158S ホルダはホルダの勝手 (R158S、L158S) と逆勝手のクランプ (SHL、SHR) が付きます。

適用チップ	型番	在庫	単価		寸法 (mm)					クランプ		クランプ スクリュー	スプリング	レンチ	
			R 右勝手	L 左勝手	H	B	L	L ₁	B ₁	D	L158S用 SHR	R158S用 SHL			
3	R/L 158S-3225 × 12 × 3/40-50		65,580	72,100											
	R/L 158S-3225 × 12 × 3/50-60T		65,580	72,100											
	R/L 158S-3225 × 12 × 3/60-75T		65,580	72,100											
	R/L 158S-3225 × 12 × 3/75-100T		65,580	72,100											
	R/L 158S-3225 × 12 × 3/100-140T		65,580	72,100	32	25	170	12	3						
	R/L 158S-3225 × 12 × 3/140-190T		65,580	72,100											
	R/L 158S-3225 × 12 × 3/190-300T		65,580	72,100											
	R/L 158S-3225 × 12 × 3/300-500T		65,580	72,100											
R/L 158S-3225 × 12 × 3/500-∞ T		65,580	72,100												
チップ幅 4.0 (4.1) mm 端面径φ 30mm 以上															
3	R/L 158S-2020 × 12 × 4/30-40		62,680	68,960											
	R/L 158S-2020 × 12 × 4/40-50		62,680	68,960											
	R/L 158S-2020 × 12 × 4/50-60T		62,680	68,960											
	R/L 158S-2020 × 12 × 4/60-75T		62,680	68,960											
	R/L 158S-2020 × 12 × 4/75-100T		62,680	68,960	20	20	125	12	4-4.5						
	R/L 158S-2020 × 12 × 4/100-140T		62,680	68,960											
	R/L 158S-2020 × 12 × 4/140-190T		62,680	68,960											
	R/L 158S-2020 × 12 × 4/190-∞ T		62,680	68,960											
	R/L 158S-2020 × 20 × 4/30-35		64,130	68,960											
	R/L 158S-2020 × 20 × 4/35-40		64,130	70,520											
	R/L 158S-2020 × 20 × 4/40-50		64,130	70,520											
	R/L 158S-2020 × 20 × 4/50-60		64,130	70,520											
	R/L 158S-2020 × 20 × 4/60-75		64,130	70,520	20	20	125	20	4-4.5						
	R/L 158S-2020 × 20 × 4/75-100		64,130	70,520											
	R/L 158S-2020 × 20 × 4/100-140		64,130	70,520											
	R/L 158S-2020 × 20 × 4/140-190		64,130	70,520											
R/L 158S-2020 × 20 × 4/190-300		64,130	70,520												
R/L 158S-2020 × 20 × 4/300-∞		64,130	70,520												
4	R/L 158S-2525 × 12 × 4/30-40	○	64,850	71,370											
	R/L 158S-2525 × 12 × 4/40-50	○	64,850	71,370											
	R/L 158S-2525 × 12 × 4/50-60T	○	64,850	71,370											
	R/L 158S-2525 × 12 × 4/60-75T	○	64,850	71,370											
	R/L 158S-2525 × 12 × 4/75-100T	○	64,850	71,370	25	25	150	12	4-4.5						
	R/L 158S-2525 × 12 × 4/100-140T	○	64,850	71,370											
	R/L 158S-2525 × 12 × 4/140-190T	○	64,850	71,370											
	R/L 158S-2525 × 12 × 4/190-∞ T	○	64,850	71,370											
	R/L 158S-2525 × 20 × 4/30-35	○	67,140	73,900											
	R/L 158S-2525 × 20 × 4/35-40	○	67,140	73,900											
	R/L 158S-2525 × 20 × 4/40-50	○	67,140	73,900											
	R/L 158S-2525 × 20 × 4/50-60	○	67,140	73,900											
	R/L 158S-2525 × 20 × 4/60-75	○	67,140	73,900	25	25	150	20	4-4.5						
	R/L 158S-2525 × 20 × 4/75-100	○	67,140	73,900											
	R/L 158S-2525 × 20 × 4/100-140	○	67,140	73,900											
	R/L 158S-2525 × 20 × 4/140-190	○	67,140	73,900											
R/L 158S-2525 × 20 × 4/190-300	○	67,140	73,900												
R/L 158S-2525 × 20 × 4/300-∞	○	67,140	73,900												
R/L 158S-2525 × 25 × 4/50-60	○	73,310	80,670												
R/L 158S-2525 × 25 × 4/60-75	○	73,310	80,670	25	25	150	25	4-4.5							
R/L 158S-2525 × 25 × 4/75-100	○	73,310	80,670												

◎：左右両勝手在庫 ○：右勝手のみ在庫 空欄：メーカー（海外）または受注生産

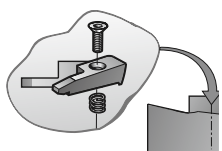

レンチ以外のパーツはホルダに付属しています。

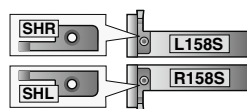

※) 158Sホルダはホルダの勝手 (R158S、L158S) と逆勝手のクランプ (SHL、SHR) が付きます。

158S 端面溝入れ 4-5mm

R158S
正回転用

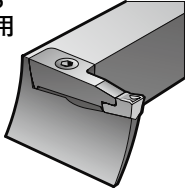

L158S
逆回転用

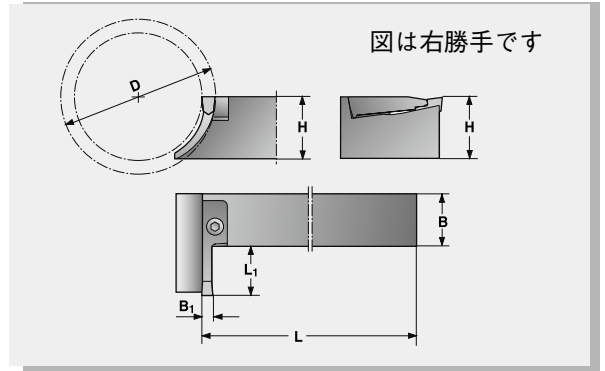
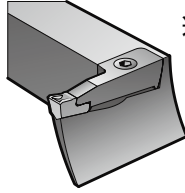

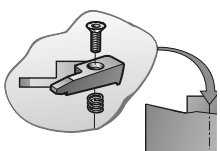

適用チップ	型番	在庫	単価		寸法 (mm)					クランプ		クランプ スクリュー	スプリング	レンチ	
			R 右勝手	L 左勝手	H	B	L	L1	B1	D	L158S用 SHR	R158S用 SHL			
4	R/L 158S-2525 × 25 × 4/100-140	○	73,310	80,670						100-140					
	R/L 158S-2525 × 25 × 4/140-190		73,310	80,670						140-190	*) SHR 254MT	*) SHL 254MT	F6S-418	BF 04M	NY 2.5
	R/L 158S-2525 × 25 × 4/190-300		73,310	80,670	25	25	150	25	4-4.5	190-300					
	R/L 158S-2525 × 25 × 4/300-∞		73,310	80,670						300-∞					
	R/L 158S-3225 × 12 × 4/40-50		65,580	72,100						40-50					
	R/L 158S-3225 × 12 × 4/50-60T		65,580	72,100						50-60					
	R/L 158S-3225 × 12 × 4/60-75T		65,580	72,100						60-75					
	R/L 158S-3225 × 12 × 4/75-100T		65,580	72,100	32	25	170	12	4-4.5	75-100	*) SHR 134	*) SHL 134	F6S-411	—	NY 2.5
	R/L 158S-3225 × 12 × 4/100-140T		65,580	72,100						100-140					
	R/L 158S-3225 × 12 × 4/140-190T		65,580	72,100						140-190					
	R/L 158S-3225 × 12 × 4/190-∞ T		65,580	72,100						190-∞					
	R/L 158S-3225 × 20 × 4/50-60		68,960	75,840						50-60					
	R/L 158S-3225 × 20 × 4/60-75		68,960	75,840						60-75					
	R/L 158S-3225 × 20 × 4/75-100		68,960	75,840						75-100					
	R/L 158S-3225 × 20 × 4/100-140		68,960	75,840	32	25	170	20	4-4.5	100-140	*) SHR 204MT	*) SHL 204MT	F6S-418	—	NY 2.5
	R/L 158S-3225 × 20 × 4/140-190		68,960	75,840						140-190					
	R/L 158S-3225 × 20 × 4/190-300		68,960	75,840						190-300					
	R/L 158S-3225 × 20 × 4/300-∞		68,960	75,840						300-∞					
	R/L 158S-3225 × 25 × 4/50-60		75,240	82,720						50-60					
	R/L 158S-3225 × 25 × 4/60-75		75,240	82,720						60-75					
	R/L 158S-3225 × 25 × 4/75-100		75,240	82,720						75-100					
	R/L 158S-3225 × 25 × 4/100-140		75,240	82,720	32	25	170	12	4-4.5	100-140	*) SHR 254MT	*) SHL 254MT	F6S-418	BF 04M	NY 2.5
	R/L 158S-3225 × 25 × 4/140-190		75,240	82,720						140-190					
	R/L 158S-3225 × 25 × 4/190-300		75,240	82,720						190-300					
R/L 158S-3225 × 25 × 4/300-∞		75,240	82,720						300-∞						
チップ幅 5.1mm 端面径φ 30mm 以上															
5	R/L 158S-2020 × 12 × 5/30-40		62,680	68,960						30-40	*) SHR 135P	*) SHL 135P			
	R/L 158S-2020 × 12 × 5/40-50		62,680	68,960						40-50					
	R/L 158S-2020 × 12 × 5/50-60T		62,680	68,960						50-60					
	R/L 158S-2020 × 12 × 5/60-75T		62,680	68,960						60-75					
	R/L 158S-2020 × 12 × 5/75-100T		62,680	68,960	20	20	110	20	5	75-100	*) SHR 135	*) SHL 135	F6S-411	—	NY 2.5
	R/L 158S-2020 × 12 × 5/100-140T		62,680	68,960						100-140					
	R/L 158S-2020 × 12 × 5/140-190T		62,680	68,960						140-190					
	R/L 158S-2020 × 12 × 5/190-∞ T		62,680	68,960						190-∞					
	R/L 158S-2020 × 20 × 5/30-40		64,130	70,520	20	20	125	20	5	30-40	*) SHR 205MP	*) SHL 205MP	F6S-418	BF 04M	NY 2.5
	R/L 158S-2020 × 20 × 5/40-50		64,130	70,520						40-50	*) SHR 205MT	*) SHL 205MT			

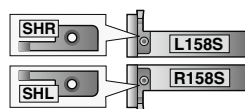

レンチ以外のパーツはホルダに
付属しています。

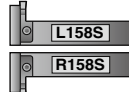

※) 158S ホルダは
ホルダの勝手 (R158S、L158S) と
逆勝手のクランプ (SHL、SHR) が付き
ます。

適用チップ	型番 	在庫	単価		寸法 (mm)					クランプ		クランプ スクリュー	スプリング	レンチ												
			R 右勝手	L 左勝手	H	B	L	L ₁	B ₁	D	L158S用 SHR	R158S用 SHL														
5	R/L 158S-2020 × 20 × 5/50-60		64,130	70,520																						
	R/L 158S-2020 × 20 × 5/60-75		64,130	70,520																						
	R/L 158S-2020 × 20 × 5/75-100		64,130	70,520																						
	R/L 158S-2020 × 20 × 5/100-140		64,130	70,520	20	20	125	20	5	50-60 60-75 75-100 100-140 140-190 190-300 300-∞	*) SHR 205MT	*) SHL 205MT	F6S-418	BF 04M	NY 2.5											
	R/L 158S-2020 × 20 × 5/140-190		64,130	70,520																						
	R/L 158S-2020 × 20 × 5/190-300		64,130	70,520																						
	R/L 158S-2020 × 20 × 5/300-∞		64,130	70,520																						
	R/L 158S-2525 × 12 × 5/30-40	○	64,850	71,370												25	25	150	12	5	30-40 40-50 50-60 60-75 75-100 100-140 140-190 190-∞	*) SHR 135P	*) SHL 135P	F6S-411	BF 04M	NY 2.5
	R/L 158S-2525 × 12 × 5/40-50	○	64,850	71,370																						
	R/L 158S-2525 × 12 × 5/50-60T	○	64,850	71,370																						
	R/L 158S-2525 × 12 × 5/60-75T		64,850	71,370																						
	R/L 158S-2525 × 12 × 5/75-100T		64,850	71,370																						
	R/L 158S-2525 × 12 × 5/100-140T		64,850	71,370																						
	R/L 158S-2525 × 12 × 5/140-190T		64,850	71,370																						
	R/L 158S-2525 × 12 × 5/190-∞ T		64,850	71,370																						
	R/L 158S-2525 × 20 × 5/30-40		67,140	73,900	25	25	150	20	5	30-40 40-50 50-60 60-75 75-100 100-140 140-190 190-300 300-∞	*) SHR 205MP	*) SHL 205MP	F6S-418	BF 04M	NY 2.5											
	R/L 158S-2525 × 20 × 5/40-50		67,140	73,900																						
	R/L 158S-2525 × 20 × 5/50-60		67,140	73,900																						
	R/L 158S-2525 × 20 × 5/60-75	○	67,140	73,900																						
	R/L 158S-2525 × 20 × 5/75-100	○	67,140	73,900																						
	R/L 158S-2525 × 20 × 5/100-140	○	67,140	73,900																						
	R/L 158S-2525 × 20 × 5/140-190		67,140	73,900																						
	R/L 158S-2525 × 20 × 5/190-300		67,140	73,900																						
	R/L 158S-2525 × 20 × 5/300-∞		67,140	73,900																						
	R/L 158S-2525 × 25 × 5/50-60	○	73,310	80,670	25	25	150	25	5	50-60 60-75 75-100 100-140 140-190 190-300 300-∞	*) SHR 255MT	*) SHL 255MT	F6S-418	BF 04M	NY 2.5											
	R/L 158S-2525 × 25 × 5/60-75	○	73,310	80,670																						
	R/L 158S-2525 × 25 × 5/75-100	○	73,310	80,670																						
	R/L 158S-2525 × 25 × 5/100-140	○	73,310	80,670																						
R/L 158S-2525 × 25 × 5/140-190		73,310	80,670																							
R/L 158S-2525 × 25 × 5/190-300		73,310	80,670																							
R/L 158S-2525 × 25 × 5/300-∞		73,310	80,670																							
R/L 158S-3225 × 12 × 5/40-50		65,580	72,100	32	25	170	12	5	40-50 50-60 60-75 75-100 100-140 140-190 190-∞	*) SHR 135	*) SHL 135	F6S-411	—	NY 2.5												
R/L 158S-3225 × 12 × 5/50-60T		65,580	72,100																							
R/L 158S-3225 × 12 × 5/60-75T		65,580	72,100																							
R/L 158S-3225 × 12 × 5/75-100T		65,580	72,100																							
R/L 158S-3225 × 12 × 5/100-140T		65,580	72,100																							
R/L 158S-3225 × 12 × 5/140-190T		65,580	72,100																							
R/L 158S-3225 × 12 × 5/190-∞ T		65,580	72,100																							
R/L 158S-3225 × 20 × 5/40-50		68,960	75,840	32	25	170	20	5	40-50 50-60 60-75 75-100 100-140 140-190 190-300 300-∞	*) SHR 205MT	*) SHL 205MT	F6S-418	BF 04M	NY 2.5												
R/L 158S-3225 × 20 × 5/50-60		68,960	75,840																							
R/L 158S-3225 × 20 × 5/60-75		68,960	75,840																							
R/L 158S-3225 × 20 × 5/75-100		68,960	75,840																							
R/L 158S-3225 × 20 × 5/100-140		68,960	75,840																							
R/L 158S-3225 × 20 × 5/140-190		68,960	75,840																							
R/L 158S-3225 × 20 × 5/190-300		68,960	75,840																							
R/L 158S-3225 × 20 × 5/300-∞		68,960	75,840																							
R/L 158S-3225 × 25 × 5/50-60		75,240	82,720	32	25	170	25	5	50-60 60-75 75-100 100-140	*) SHR 255MT	*) SHL 255MT	F6S-418	BF 04M	NY 2.5												
R/L 158S-3225 × 25 × 5/60-75		75,240	82,720																							
R/L 158S-3225 × 25 × 5/75-100		75,240	82,720																							
R/L 158S-3225 × 25 × 5/100-140		75,240	82,720																							

◎：左右両勝手が在庫 ○：右勝手のみ在庫 空欄：メーカー（海外）または受注生産

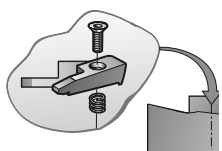

レンチ以外のパーツはホルダに付属しています。

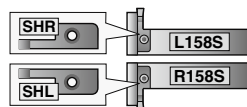

※) 158Sホルダはホルダの勝手 (R158S、L158S) と逆勝手のクランプ (SHL、SHR) が付きます。

158S 端面溝入れ 5-8mm

R158S
正回転用

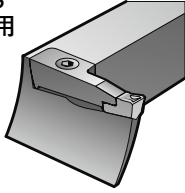

L158S
逆回転用

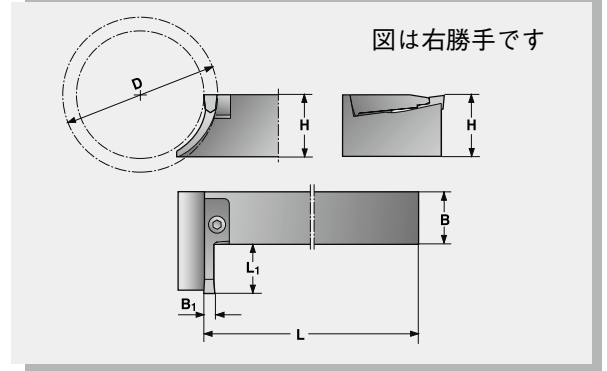
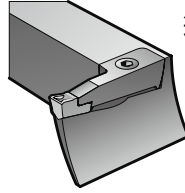

適用チップ	型番	在庫	単価		寸法 (mm)					クランプ		クランプ スクリュー	スプリング	レンチ	
			R 右勝手	L 左勝手	H	B	L	L1	B1	D	L158S用 SHR	R158S用 SHL			
5	R/L 158S-3225 × 25 × 5/140-190		75,240	82,720						140-190	※) SHR 255MT	※) SHL 255MT	F6S-418	BF 04M	NY 2.5
	R/L 158S-3225 × 25 × 5/190-300		75,240	82,720	32	25	170	25	5	190-300					
	R/L 158S-3225 × 25 × 5/300-∞		75,240	82,720						300-∞					

チップ幅 6.1mm 端面径φ 40mm 以上

6	R/L 158S-2020 × 12 × 6/40-50		62,680	68,960						40-50					
	R/L 158S-2020 × 12 × 6/50-60T		62,680	68,960						50-60					
	R/L 158S-2020 × 12 × 6/60-75T		62,680	68,960						60-75	※) SHR 136	※) SHL 136	F6S-411	—	NY 2.5
	R/L 158S-2020 × 12 × 6/75-100T		62,680	68,960	20	20	125	12	6-7.5	75-100					
	R/L 158S-2020 × 12 × 6/100-140T		62,680	68,960						100-140					
	R/L 158S-2020 × 12 × 6/140-190T		62,680	68,960						140-190					
	R/L 158S-2020 × 12 × 6/190-∞ T		62,680	68,960						190-∞					
	R/L 158S-2020 × 20 × 6/40-50		64,130	70,520						40-50					
	R/L 158S-2020 × 20 × 6/50-60		64,130	70,520						50-60					
	R/L 158S-2020 × 20 × 6/60-75		64,130	70,520						60-75	※) SHR 206MT	※) SHL 206MT	F6S-418	BF 04M	NY 2.5
	R/L 158S-2020 × 20 × 6/75-100		64,130	70,520	20	20	125	20	6-7.5	75-100					
	R/L 158S-2020 × 20 × 6/100-140		64,130	70,520						100-140					
R/L 158S-2020 × 20 × 6/140-190		64,130	70,520						140-190						
R/L 158S-2020 × 20 × 6/190-300		64,130	70,520						190-300						
R/L 158S-2020 × 20 × 6/300-∞		64,130	70,520						300-∞						
6	R/L 158S-2525 × 12 × 6/40-50		64,850	71,370						40-50					
	R/L 158S-2525 × 12 × 6/50-60T		64,850	71,370						50-60					
	R/L 158S-2525 × 12 × 6/60-75T		64,850	71,370						60-75	※) SHR 136	※) SHL 136	F6S-411	—	NY 2.5
	R/L 158S-2525 × 12 × 6/75-100T		64,850	71,370	25	25	150	12	6-7.5	75-100					
	R/L 158S-2525 × 12 × 6/100-140T		64,850	71,370						100-140					
	R/L 158S-2525 × 12 × 6/140-190T		64,850	71,370						140-190					
	R/L 158S-2525 × 12 × 6/190-∞ T		64,850	71,370						190-∞					
	R/L 158S-2525 × 20 × 6/40-50		67,140	73,900						40-50					
	R/L 158S-2525 × 20 × 6/50-60		67,140	73,900						50-60					
	R/L 158S-2525 × 20 × 6/60-75		67,140	73,900						60-75	※) SHR 206MT	※) SHL 206MT	F6S-418	BF 04M	NY 2.5
	R/L 158S-2525 × 20 × 6/75-100		67,140	73,900	25	25	150	20	6-7.5	75-100					
	R/L 158S-2525 × 20 × 6/100-140		67,140	73,900						100-140					
R/L 158S-2525 × 20 × 6/140-190		67,140	73,900						140-190						
R/L 158S-2525 × 20 × 6/190-300		67,140	73,900						190-300						
R/L 158S-2525 × 20 × 6/300-∞		67,140	73,900						300-∞						
R/L 158S-2525 × 25 × 6/50-60		73,310	80,670	25	25	150	25	6-7.5	50-60	※) SHR 256MT	※) SHL 256MT	F6S-418	BF 04M	NY 2.5	
R/L 158S-2525 × 25 × 6/60-75		73,310	80,670						60-75						

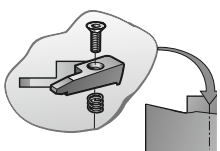

レンチ以外のパーツはホルダに
付属しています。

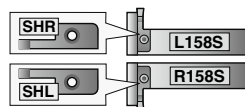

※) 158S ホルダは
ホルダの勝手 (R158S、L158S) と
逆勝手のクランプ (SHL、SHR) が付き
ます。

適用チップ	型番 	在庫	単価		寸法 (mm)					クランプ		クランプ スクリュー	スプリング	レンチ	
			R 右勝手	L 左勝手	H	B	L	L1	B1	D	L158S用 SHR	R158S用 SHL			
6	R/L 158S-2525 × 25 × 6/75-100	在	73,310	80,670						75-100	*) SHR 256MT	*) SHL 256MT	F6S-418	BF 04M	NY 2.5
	R/L 158S-2525 × 25 × 6/100-140	庫	73,310	80,670					100-140						
	R/L 158S-2525 × 25 × 6/140-190		73,310	80,670	25	25	150	25	6-7.5	140-190					
	R/L 158S-2525 × 25 × 6/190-300		73,310	80,670						190-300					
	R/L 158S-2525 × 25 × 6/300-∞		73,310	80,670						300-∞					
	R/L 158S-3225 × 12 × 6/40-50		65,580	72,100						40-50	*) SHR 136	*) SHL 136	F6S-411	-	NY 2.5
	R/L 158S-3225 × 12 × 6/50-60T		65,580	72,100						50-60					
	R/L 158S-3225 × 12 × 6/60-75T		65,580	72,100						60-75					
	R/L 158S-3225 × 12 × 6/75-100T		65,580	72,100	32	25	170	12	6-7.5	75-100					
	R/L 158S-3225 × 12 × 6/100-140T		65,580	72,100						100-140					
	R/L 158S-3225 × 12 × 6/140-190T		65,580	72,100						140-190					
	R/L 158S-3225 × 12 × 6/190-∞ T		65,580	72,100						190-∞					
R/L 158S-3225 × 20 × 6/40-50		68,960	75,840						40-50	*) SHR 206MT	*) SHL 206MT	F6S-418	BF 04M	NY 2.5	
R/L 158S-3225 × 20 × 6/50-60		68,960	75,840						50-60						
R/L 158S-3225 × 20 × 6/60-75		68,960	75,840						60-75						
R/L 158S-3225 × 20 × 6/75-100		68,960	75,840	32	25	170	20	6-7.5	75-100						
R/L 158S-3225 × 20 × 6/100-140		68,960	75,840						100-140						
R/L 158S-3225 × 20 × 6/140-190		68,960	75,840						140-190						
R/L 158S-3225 × 20 × 6/190-300		68,960	75,840						190-300						
R/L 158S-3225 × 20 × 6/300-∞		68,960	75,840						300-∞						
R/L 158S-3225 × 25 × 6/50-60		75,240	82,720						50-60	*) SHR 256MT	*) SHL 256MT	F6S-418	BF 04M	NY 2.5	
R/L 158S-3225 × 25 × 6/60-75		75,240	82,720						60-75						
R/L 158S-3225 × 25 × 6/75-100		75,240	82,720						75-100						
R/L 158S-3225 × 25 × 6/100-140		75,240	82,720	32	25	170	25	6-7.5	100-140						
R/L 158S-3225 × 25 × 6/140-190		75,240	82,720						140-190						
R/L 158S-3225 × 25 × 6/190-300		75,240	82,720						190-300						
R/L 158S-3225 × 25 × 6/300-∞		75,240	82,720						300-∞						
R/L 158S-3232 × 32 × 6/50-60		80,910	89,000						50-60	*) SHR 326MT	*) SHL 326MT	F6S-519	BF 05M	NY 3	
R/L 158S-3232 × 32 × 6/60-75		80,910	89,000						60-75						
R/L 158S-3232 × 32 × 6/75-100	○	80,910	89,000						75-100						
R/L 158S-3232 × 32 × 6/100-140		80,910	89,000	32	32	170	32	6-7.5	100-140						
R/L 158S-3232 × 32 × 6/140-190		80,910	89,000						140-190						
R/L 158S-3232 × 32 × 6/190-300		80,910	89,000						190-300						
R/L 158S-3232 × 32 × 6/300-∞		80,910	89,000						300-∞						
R/L 158S-4032 × 32 × 6/140-190		84,770	93,220						140-190						*) SHR 326MT
R/L 158S-4032 × 32 × 6/190-300		84,770	93,220	40	32	200	32	6-7.5	190-300						
R/L 158S-4032 × 32 × 6/300-∞		84,770	93,220						300-∞						
チップ幅 8.1 ~ 12.1mm 端面径φ 75mm 以上															
8	R/L 158S-2525 × 20 × 8/75-100		68,230	75,110						75-100	*) SHR 208MT	*) SHL 208MT	F6S-519	BF 05M	NY 3
	R/L 158S-2525 × 20 × 8/100-140		68,230	75,110						100-140					
	R/L 158S-2525 × 20 × 8/140-190		68,230	75,110	25	25	150	20	8-9	140-190					
	R/L 158S-2525 × 20 × 8/190-∞		68,230	75,110						190-∞					
	R/L 158S-3225 × 20 × 8/75-100		72,940	80,180						75-100	*) SHR 208MT	*) SHL 208MT	F6S-519	BF 05M	NY 3
	R/L 158S-3225 × 20 × 8/100-140		72,940	80,180						100-140					
	R/L 158S-3225 × 20 × 8/140-190		72,940	80,180	32	25	170	20	8-9	140-190					
	R/L 158S-3225 × 20 × 8/190-∞		72,940	80,180						190-∞					
	R/L 158S-4032 × 30 × 8/75-100		91,530	100,710						75-100	*) SHR 308MT	*) SHL 308MT	F6S-519	BF 05M	NY 3
	R/L 158S-4032 × 30 × 8/100-140		91,530	100,710						100-140					
R/L 158S-4032 × 30 × 8/140-190		91,530	100,710	40	32	200	30	8-9	140-190						

◎：左右両勝手が在庫 ○：右勝手のみ在庫 空欄：メーカー（海外）または受注生産

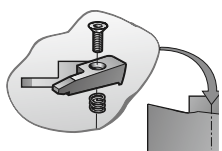

レンチ以外のパーツはホルダに付属しています。

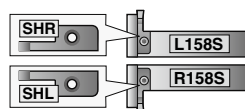

※) 158Sホルダはホルダの勝手 (R158S、L158S) と逆勝手のクランプ (SHL、SHR) が付きます。

外径溝入れ
突切り
端面溝入れ
内径溝入れ
シームレス防振
ヌスミ溝入れ
チップ
切削条件表
自動盤工具

158S 端面溝入れ 8-12mm

R158S
正回転用

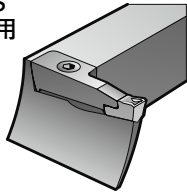

L158S
逆回転用

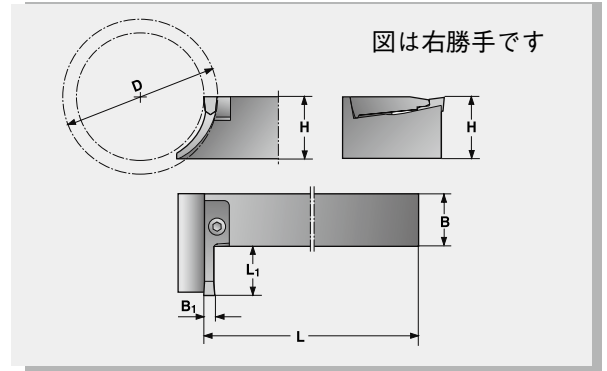
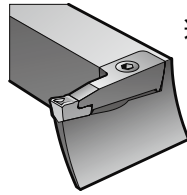

適用チップ	型番	在庫	単価		寸法 (mm)					クランプ		クランプ スクリュー	スプリング	レンチ		
			R 右勝手	L 左勝手	H	B	L	L1	B1	D	L158S 用 SHR	R158S 用 SHL	F6S-519	BF 05M	NY 3	
			R/L158S 共通 SHN													
8	R/L 158S-4032 × 30 × 8/190-300		91,530	100,710	40	32	200	30	8-9	190-300	*) SHR 308MT	*) SHL 308MT	F6S-418	BF 04T	NY 2.5	
	R/L 158S-4032 × 30 × 8/300-∞		91,530	100,710						300-∞						
	*)R/L 158S-4032 × 50 × 8/140-190		98,540	108,440	40	32	200	50	8-9	140-190	SHN 8T					
	*)R/L 158S-4032 × 50 × 8/190-300		98,540	108,440												190-300
	*)R/L 158S-4032 × 50 × 8/300-500		98,540	108,440												
*)R/L 158S-4032 × 50 × 8/500-∞		98,540	108,440	500-∞												
10	R/L 158S-3225 × 20 × 10/75-100		72,940	80,180	32	25	170	20	10-11	75-100	*) SHR 2010MT	*) SHL 2010MT	F6S-519	BF 05M	NY 3	
	R/L 158S-3225 × 20 × 10/100-140		72,940	80,180						100-140						
	R/L 158S-3225 × 20 × 10/140-190		72,940	80,180						140-190						
	R/L 158S-3225 × 20 × 10/190-∞		72,940	80,180						190-∞						
	R/L 158S-4032 × 30 × 10/75-100		91,530	100,710	40	32	200	30	10-11	75-100	*) SHR 3010MT	*) SHL 3010MT	F6S-519	BF 05M	NY 3	
	R/L 158S-4032 × 30 × 10/100-140		91,530	100,710						100-140						
	R/L 158S-4032 × 30 × 10/140-190		91,530	100,710						140-190						
	R/L 158S-4032 × 30 × 10/190-300		91,530	100,710						190-300						
R/L 158S-4032 × 30 × 10/300-∞		91,530	100,710	300-∞												
*)R/L 158S-4032 × 50 × 10/140-190		98,540	108,440	40	32	200	50	10-11	140-190	SHN 10T		F6S-518T	BF 05T	NY 3		
*)R/L 158S-4032 × 50 × 10/190-300		98,540	108,440						190-300							
*)R/L 158S-4032 × 50 × 10/300-∞		98,540	108,440						300-∞							
*)R/L 158S-4032 × 50 × 10/300-∞		98,540	108,440													
12	R/L 158S-4032 × 30 × 12/75-100		91,530	100,710	40	32	200	30	12	75-100	*) SHR 3012MT	*) SHL 3012MT	F6S-519	BF 05M	NY 3	
	R/L 158S-4032 × 30 × 12/100-140		91,530	100,710						100-140						
	R/L 158S-4032 × 30 × 12/140-190		91,530	100,710						140-190						
	R/L 158S-4032 × 30 × 12/190-300		91,530	100,710						190-300						
	R/L 158S-4032 × 30 × 12/300-∞		91,530	100,710	300-∞											
	*)R/L 158S-4032 × 50 × 12/140-190		98,540	108,440	40	32	200	50	12	140-190	SHN 12T		F6S-519	BF 05T	NY 3	
	*)R/L 158S-4032 × 50 × 12/190-300		98,540	108,440						190-300						
*)R/L 158S-4032 × 50 × 12/300-∞		98,540	108,440	300-∞												

注文例：R158S-2020 × 12 × 4/50-60...2本 ◎：左右両勝手在庫 ○：右勝手のみ在庫 空欄：メーカー（海外）または受注生産

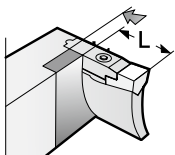

1) ホルダを修正することにより、より深い切込が可能です。

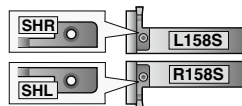

※) 158Sホルダはホルダの勝手 (R158S、L158S) と逆勝手のクランプ (SHL、SHR) が付きます。