

153S 端面溝入れ 3-4mm

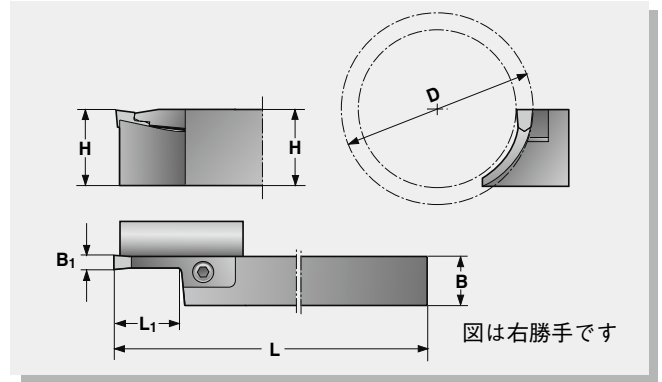
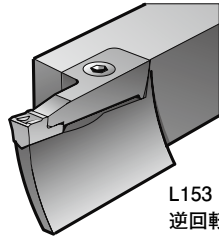
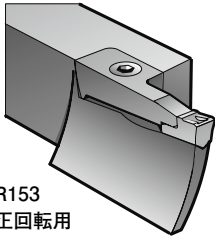

| 適用チップ | 型番 | 在庫 | 単価 | | 寸法 (mm) | | | | | クランプ | | クランプ スクリュー | スプリング | レンチ |
|-------|----|----|----------|----------|---------|---|---|----------------|----------------|------|----------------|---------------|-------|-----|
| | | | R 右勝手 | L 左勝手 | H | B | L | L ₁ | B ₁ | D | L153S 用 SHR | | | |

チップ幅 3.0 (3.2) mm 端面径φ 20mm 以上

| | | | | | | | | | | | | | | | |
|---|---------------------------------|---|--------|--------|---------|-------------|-------------|---------|---|---------|-------------|-------------|---------|---|--------|
| ※ | R/L 153S-1616 × 12 × 3/20-23 | | 42,390 | 46,610 | | | | | | 20-23 | ※) SHR 133Z | ※) SHL 133Z | F6S-411 | — | NY 2.5 |
| ※ | R/L 153S-1616 × 12 × 3/23-26 | | 42,390 | 46,610 | 16 | 16 | 110 | 12 | 3 | 23-26 | ※) SHR 133Z | ※) SHL 133Z | | | |
| ※ | R/L 153S-1616 × 12 × 3/26-30 | | 42,390 | 46,610 | | | | | | 26-30 | ※) SHR 133P | ※) SHL 133P | | | |
| | R/L 153S-1616 × 12 × 3/30-35 | | 42,390 | 46,610 | | | | | | 30-35 | ※) SHR 133P | ※) SHL 133P | | | |
| | R/L 153S-1616 × 12 × 3/35-40 | | 42,390 | 46,610 | | | | | | 35-40 | ※) SHR 133 | ※) SHL 133 | | | |
| | R/L 153S-1616 × 12 × 3/40-50 | | 42,390 | 46,610 | | | | | | 40-50 | ※) SHR 133 | ※) SHL 133 | | | |
| ※ | R/L 153S-2020 × 12 × 3/20-23 | | 42,390 | 46,610 | | | | | | 20 | 20 | 125 | 12 | 3 | 20-23 |
| ※ | R/L 153S-2020 × 12 × 3/23-26 | | 42,390 | 46,610 | 23-26 | ※) SHR 133Z | ※) SHL 133Z | | | | | | | | |
| ※ | R/L 153S-2020 × 12 × 3/26-30 | ○ | 42,390 | 46,610 | 26-30 | ※) SHR 133P | ※) SHL 133P | | | | | | | | |
| | R/L 153S-2020 × 12 × 3/30-35 | ○ | 42,390 | 46,610 | 30-35 | ※) SHR 133P | ※) SHL 133P | | | | | | | | |
| | R/L 153S-2020 × 12 × 3/35-40 | ○ | 42,390 | 46,610 | 35-40 | ※) SHR 133 | ※) SHL 133 | | | | | | | | |
| | R/L 153S-2020 × 12 × 3/40-50 | ○ | 42,390 | 46,610 | 40-50 | ※) SHR 133 | ※) SHL 133 | | | | | | | | |
| | R/L 153S-2020 × 12 × 3/50-60T | | 42,390 | 46,610 | 50-60 | | | F6S-411 | — | | | | | | NY 2.5 |
| | R/L 153S-2020 × 12 × 3/60-75T | | 42,390 | 46,610 | 60-75 | | | | | | | | | | |
| | R/L 153S-2020 × 12 × 3/75-100T | | 42,390 | 46,610 | 75-100 | ※) SHR 133 | ※) SHL 133 | | | | | | | | |
| | R/L 153S-2020 × 12 × 3/100-140T | | 42,390 | 46,610 | 100-140 | ※) SHR 133 | ※) SHL 133 | | | | | | | | |
| | R/L 153S-2020 × 12 × 3/140-190T | | 42,390 | 46,610 | 140-190 | | | | | | | | | | |
| | R/L 153S-2020 × 12 × 3/190-300T | | 42,390 | 46,610 | 190-300 | | | | | | | | | | |
| 3 | R/L 153S-2020 × 12 × 3/300-500T | | 42,390 | 46,610 | 300-500 | | | | | | | | | | |
| | R/L 153S-2020 × 12 × 3/500-∞ T | | 42,390 | 46,610 | 500-∞ | | | | | | | | | | |
| ※ | R/L 153S-2525 × 12 × 3/20-23 | ○ | 45,890 | 50,480 | 25 | 25 | 150 | 12 | 3 | 20-23 | ※) SHR 133Z | ※) SHL 133Z | F6S-411 | — | NY 2.5 |
| ※ | R/L 153S-2525 × 12 × 3/23-26 | ○ | 45,890 | 50,480 | | | | | | 23-26 | ※) SHR 133Z | ※) SHL 133Z | | | |
| ※ | R/L 153S-2525 × 12 × 3/26-30 | ○ | 45,890 | 50,480 | | | | | | 26-30 | ※) SHR 133P | ※) SHL 133P | | | |
| | R/L 153S-2525 × 12 × 3/30-35 | ○ | 45,890 | 50,480 | | | | | | 30-35 | ※) SHR 133P | ※) SHL 133P | | | |
| | R/L 153S-2525 × 12 × 3/35-40 | ○ | 45,890 | 50,480 | | | | | | 35-40 | ※) SHR 133 | ※) SHL 133 | | | |
| | R/L 153S-2525 × 12 × 3/40-50 | ○ | 45,890 | 50,480 | | | | | | 40-50 | ※) SHR 133 | ※) SHL 133 | | | |
| | R/L 153S-2525 × 12 × 3/50-60T | ○ | 45,890 | 50,480 | | | | | | 50-60 | | | F6S-411 | — | NY 2.5 |
| | R/L 153S-2525 × 12 × 3/60-75T | ○ | 45,890 | 50,480 | | | | | | 60-75 | | | | | |
| | R/L 153S-2525 × 12 × 3/75-100T | ○ | 45,890 | 50,480 | | | | | | 75-100 | ※) SHR 133 | ※) SHL 133 | | | |
| | R/L 153S-2525 × 12 × 3/100-140T | ○ | 45,890 | 50,480 | | | | | | 100-140 | ※) SHR 133 | ※) SHL 133 | | | |
| | R/L 153S-2525 × 12 × 3/140-190T | ○ | 45,890 | 50,480 | | | | | | 140-190 | | | | | |
| | R/L 153S-2525 × 12 × 3/190-300T | ○ | 45,890 | 50,480 | | | | | | 190-300 | | | | | |
| | R/L 153S-2525 × 12 × 3/300-500T | ○ | 45,890 | 50,480 | 300-500 | | | | | | | | | | |
| | R/L 153S-2525 × 12 × 3/500-∞ T | ○ | 45,890 | 50,480 | 500-∞ | | | | | | | | | | |

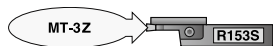





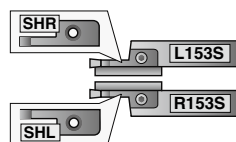

※ D 寸法 (溝外径) が、20-23、23-26、26-30 のホルダには専用チップ MT-3Z (P71) を使用してください。

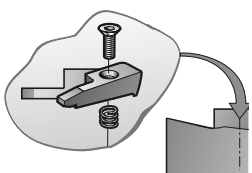
レンチ以外のパーツはホルダに付属しています。

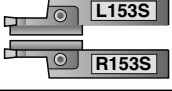

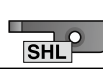
※) 153S ホルダはホルダの勝手 (R153S、L153S) と逆勝手のクランプ (SHL、SHR) が付きます。



| 適用チップ | 型番  | 在庫 | 単価 | | 寸法 (mm) | | | | | | クランプ | | クランプ スクリュー | スプリング | レンチ | |
|---------------------------------------|---|--------|----------|----------|---------|-----|-----|----------------|----------------|--------------|---|---|---|---|---|---------|
| | | | R 右勝手 | L 左勝手 | H | B | L | L ₁ | B ₁ | D | L153S用  | R153S用  |  |  |  | |
| 3 | R/L 153S-3225 × 12 × 3/40-50 | | 47,340 | 52,050 | 32 | 25 | 170 | 12 | 3 | 40-50 | *) SHR 133 | *) SHL 133 | F6S-411 | — | NY 2.5 | |
| | R/L 153S-3225 × 12 × 3/50-60T | | 47,340 | 52,050 | | | | | | | | | | | | 50-60 |
| | R/L 153S-3225 × 12 × 3/60-75T | | 47,340 | 52,050 | | | | | | | | | | | | 60-75 |
| | R/L 153S-3225 × 12 × 3/75-100T | | 47,340 | 52,050 | | | | | | | | | | | | 75-100 |
| | R/L 153S-3225 × 12 × 3/100-140T | | 47,340 | 52,050 | | | | | | | | | | | | 100-140 |
| | R/L 153S-3225 × 12 × 3/140-190T | | 47,340 | 52,050 | | | | | | | | | | | | 140-190 |
| | R/L 153S-3225 × 12 × 3/190-300T | | 47,340 | 52,050 | | | | | | | | | | | | 190-300 |
| | R/L 153S-3225 × 12 × 3/300-500T | | 47,340 | 52,050 | | | | | | | | | | | | 300-500 |
| | R/L 153S-3225 × 12 × 3/500-∞ T | | 47,340 | 52,050 | | | | | | | | | | | | 500-∞ |
| チップ幅 4.0 (4.1) mm 端面径φ 30mm 以上 | | | | | | | | | | | | | | | | |
| 4 | R/L 153S-2020 × 12 × 4/30-40 | | 42,390 | 46,610 | 20 | 20 | 125 | 12 | 4-4.5 | 30-40 | *) SHR 134P | *) SHL 134P | F6S-411 | — | NY 2.5 | |
| | R/L 153S-2020 × 12 × 4/40-50 | | 42,390 | 46,610 | | | | | | | 40-50 | | | | | |
| | R/L 153S-2020 × 12 × 4/50-60T | | 42,390 | 46,610 | | | | | | | 50-60 | | | | | |
| | R/L 153S-2020 × 12 × 4/60-75T | | 42,390 | 46,610 | | | | | | | 60-75 | | | | | |
| | R/L 153S-2020 × 12 × 4/75-100T | | 42,390 | 46,610 | | | | | | | 75-100 | | | | | |
| | R/L 153S-2020 × 12 × 4/100-140T | | 42,390 | 46,610 | | | | | | | 100-140 | | | | | |
| | R/L 153S-2020 × 12 × 4/140-190T | | 42,390 | 46,610 | | | | | | | 140-190 | | | | | |
| | R/L 153S-2020 × 12 × 4/190-∞ T | | 42,390 | 46,610 | | | | | | | 190-∞ | | | | | |
| | R/L 153S-2020 × 20 × 4/30-35 | ○ | 44,680 | 49,160 | | | | | | | 20 | 20 | | | | 125 |
| | R/L 153S-2020 × 20 × 4/35-40 | | 44,680 | 49,160 | 35-40 | | | | | | | | | | | |
| | R/L 153S-2020 × 20 × 4/40-50 | | 44,680 | 49,160 | 40-50 | | | | | | | | | | | |
| | R/L 153S-2020 × 20 × 4/50-60 | | 44,680 | 49,160 | 50-60 | | | | | | | | | | | |
| | R/L 153S-2020 × 20 × 4/60-75 | | 44,680 | 49,160 | 60-75 | | | | | | | | | | | |
| | R/L 153S-2020 × 20 × 4/75-100 | | 44,680 | 49,160 | 75-100 | | | | | | | | | | | |
| | R/L 153S-2020 × 20 × 4/100-140 | | 44,680 | 49,160 | 100-140 | | | | | | | | | | | |
| | R/L 153S-2020 × 20 × 4/140-190 | | 44,680 | 49,160 | 140-190 | | | | | | | | | | | |
| | R/L 153S-2020 × 20 × 4/190-300 | | 44,680 | 49,160 | 190-300 | | | | | | | | | | | |
| | R/L 153S-2020 × 20 × 4/300-∞ | | 44,680 | 49,160 | 300-∞ | | | | | | | | | | | |
| R/L 153S-2525 × 12 × 4/30-40 | | 45,890 | 50,480 | 25 | 25 | 150 | 12 | 4-4.5 | 30-40 | *) SHR 134P | *) SHL 134P | F6S-411 | — | NY 2.5 | | |
| R/L 153S-2525 × 12 × 4/40-50 | | 45,890 | 50,480 | | | | | | | 40-50 | | | | | | |
| R/L 153S-2525 × 12 × 4/50-60T | | 45,890 | 50,480 | | | | | | | 50-60 | | | | | | |
| R/L 153S-2525 × 12 × 4/60-75T | | 45,890 | 50,480 | | | | | | | 60-75 | | | | | | |
| R/L 153S-2525 × 12 × 4/75-100T | ◎ | 45,890 | 50,480 | | | | | | | 75-100 | | | | | | |
| R/L 153S-2525 × 12 × 4/100-140T | ○ | 45,890 | 50,480 | | | | | | | 100-140 | | | | | | |
| R/L 153S-2525 × 12 × 4/140-190T | ○ | 45,890 | 50,480 | | | | | | | 140-190 | | | | | | |
| R/L 153S-2525 × 12 × 4/190-∞ T | ○ | 45,890 | 50,480 | | | | | | | 190-∞ | | | | | | |
| R/L 153S-2525 × 20 × 4/30-35 | ○ | 49,510 | 55,790 | | | | | | | 25 | 25 | | | | 150 | 20 |
| R/L 153S-2525 × 20 × 4/35-40 | ○ | 49,510 | 55,790 | 35-40 | | | | | | | | | | | | |
| R/L 153S-2525 × 20 × 4/40-50 | ○ | 49,510 | 55,790 | 40-50 | | | | | | | | | | | | |
| R/L 153S-2525 × 20 × 4/50-60 | ○ | 49,510 | 55,790 | 50-60 | | | | | | | | | | | | |
| R/L 153S-2525 × 20 × 4/60-75 | ○ | 49,510 | 55,790 | 60-75 | | | | | | | | | | | | |
| R/L 153S-2525 × 20 × 4/75-100 | ○ | 49,510 | 55,790 | 75-100 | | | | | | | | | | | | |
| R/L 153S-2525 × 20 × 4/100-140 | ○ | 49,510 | 55,790 | 100-140 | | | | | | | | | | | | |
| R/L 153S-2525 × 20 × 4/140-190 | ○ | 49,510 | 55,790 | 140-190 | | | | | | | | | | | | |
| R/L 153S-2525 × 20 × 4/190-300 | ○ | 49,510 | 55,790 | 190-300 | | | | | | | | | | | | |
| R/L 153S-2525 × 20 × 4/300-∞ | ○ | 49,510 | 55,790 | 300-∞ | | | | | | | | | | | | |
| R/L 153S-2525 × 25 × 4/50-60 | ○ | 53,990 | 59,410 | 25 | 25 | 150 | 25 | 4-4.5 | 50-60 | *) SHR 254MT | *) SHL 254MT | F6S-418 | BF 04M | NY 2.5 | | |
| R/L 153S-2525 × 25 × 4/60-75 | ○ | 53,990 | 59,410 | | | | | | | 60-75 | | | | | | |
| R/L 153S-2525 × 25 × 4/75-100 | ○ | 53,990 | 59,410 | | | | | | | 75-100 | | | | | | |

◎：左右両勝手が在庫 ○：右勝手のみ在庫 空欄：メーカー（海外）または受注生産

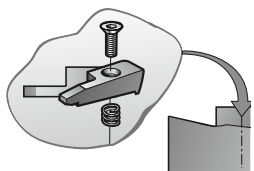

レンチ以外のパーツはホルダに
付属しています。

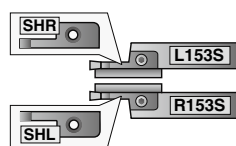

※) 153S ホルダは
ホルダの勝手 (R153S、L153S) と
逆勝手のクランプ (SHL、SHR) が付き
ます。

外径溝入れ

突切り

端面溝入れ

内径溝入れ

シームレス防振

ヌスミ溝入れ

チップ

切削条件表

自動盤工具

153S 端面溝入れ 4-5mm

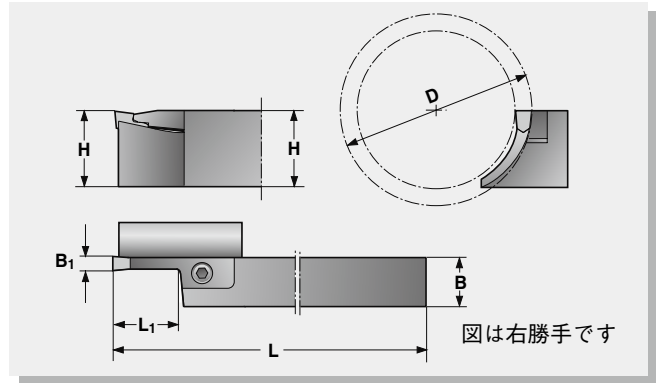
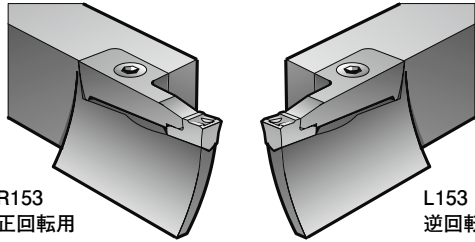

| 適用チップ | 型番 | 在庫 | 単価 | | 寸法 (mm) | | | | | | クランプ | | クランプ スクリュー | スプリング | レンチ |
|--------------------------------|---------------------------------|--------|--------|--------|---------|-----|-------|-------|-----------|-----------|-------------|-------------|------------|--------|--------|
| | | | R 右勝手 | L 左勝手 | H | B | L | L1 | B1 | D | L153S 用 SHR | R153S 用 SHL | | | |
| 4 | R/L 153S-2525 × 25 × 4/100-140 | ○ | 53,990 | 59,410 | 25 | 25 | 150 | 25 | 4-4.5 | 100-140 | SHR 254MT | SHL 254MT | F6S-418 | BF 04M | NY 2.5 |
| | R/L 153S-2525 × 25 × 4/140-190 | ○ | 53,990 | 59,410 | | | | | | | | | | | |
| | R/L 153S-2525 × 25 × 4/190-300 | ○ | 53,990 | 59,410 | | | | | | | | | | | |
| | R/L 153S-2525 × 25 × 4/300-∞ | ○ | 53,990 | 59,410 | | | | | | | | | | | |
| | R/L 153S-3225 × 12 × 4/40-50 | ○ | 47,340 | 52,050 | 32 | 25 | 170 | 12 | 4-4.5 | 40-50 | SHR 134 | SHL 134 | F6S-411 | — | NY 2.5 |
| | R/L 153S-3225 × 12 × 4/50-60T | | 47,340 | 52,050 | | | | | | | | | | | |
| | R/L 153S-3225 × 12 × 4/60-75T | | 47,340 | 52,050 | | | | | | | | | | | |
| | R/L 153S-3225 × 12 × 4/75-100T | | 47,340 | 52,050 | | | | | | | | | | | |
| | R/L 153S-3225 × 12 × 4/100-140T | | 47,340 | 52,050 | | | | | | | | | | | |
| | R/L 153S-3225 × 12 × 4/140-190T | | 47,340 | 52,050 | | | | | | | | | | | |
| | R/L 153S-3225 × 12 × 4/190-∞ T | | 47,340 | 52,050 | | | | | | | | | | | |
| | R/L 153S-3225 × 20 × 4/50-60 | | 50,720 | 55,790 | | | | | | | | | | | |
| | R/L 153S-3225 × 20 × 4/60-75 | 50,720 | 55,790 | 32 | 25 | 170 | 20 | 4-4.5 | 50-60 | SHR 204MT | SHL 204MT | F6S-418 | — | NY 2.5 | |
| | R/L 153S-3225 × 20 × 4/75-100 | 50,720 | 55,790 | | | | | | | | | | | | |
| | R/L 153S-3225 × 20 × 4/100-140 | 50,720 | 55,790 | | | | | | | | | | | | |
| | R/L 153S-3225 × 20 × 4/140-190 | 50,720 | 55,790 | | | | | | | | | | | | |
| | R/L 153S-3225 × 20 × 4/190-300 | 50,720 | 55,790 | 32 | 25 | 170 | 12 | 4-4.5 | 100-140 | SHR 254MT | SHL 254MT | F6S-418 | BF 04M | NY 2.5 | |
| | R/L 153S-3225 × 20 × 4/300-∞ | 50,720 | 55,790 | | | | | | | | | | | | |
| | R/L 153S-3225 × 25 × 4/50-60 | 55,310 | 60,860 | | | | | | | | | | | | |
| | R/L 153S-3225 × 25 × 4/60-75 | 55,310 | 60,860 | | | | | | | | | | | | |
| R/L 153S-3225 × 25 × 4/75-100 | 55,310 | 60,860 | 32 | 25 | 170 | 12 | 4-4.5 | 50-60 | SHR 254MT | SHL 254MT | F6S-418 | BF 04M | NY 2.5 | | |
| R/L 153S-3225 × 25 × 4/100-140 | 55,310 | 60,860 | | | | | | | | | | | | | |
| R/L 153S-3225 × 25 × 4/140-190 | 55,310 | 60,860 | | | | | | | | | | | | | |
| R/L 153S-3225 × 25 × 4/190-300 | 55,310 | 60,860 | | | | | | | | | | | | | |
| R/L 153S-3225 × 25 × 4/300-∞ | 55,310 | 60,860 | | | | | | | | | | | | | |
| チップ幅 5.1mm 端面径φ 30mm 以上 | | | | | | | | | | | | | | | |
| 5 | R/L 153S-2020 × 12 × 5/30-40 | | 42,390 | 46,610 | 20 | 20 | 125 | 12 | 5 | 30-40 | SHR 135P | SHL 135P | F6S-411 | — | NY 2.5 |
| | R/L 153S-2020 × 12 × 5/40-50 | | 42,390 | 46,610 | | | | | | | | | | | |
| | R/L 153S-2020 × 12 × 5/50-60T | | 42,390 | 46,610 | | | | | | | | | | | |
| | R/L 153S-2020 × 12 × 5/60-75T | | 42,390 | 46,610 | | | | | | | | | | | |
| | R/L 153S-2020 × 12 × 5/75-100T | | 42,390 | 46,610 | | | | | | | | | | | |
| | R/L 153S-2020 × 12 × 5/100-140T | | 42,390 | 46,610 | | | | | | | | | | | |
| | R/L 153S-2020 × 12 × 5/140-190T | | 42,390 | 46,610 | | | | | | | | | | | |
| | R/L 153S-2020 × 12 × 5/190-∞ T | | 42,390 | 46,610 | | | | | | | | | | | |
| R/L 153S-2020 × 20 × 5/30-40 | | 44,680 | 49,160 | 20 | 20 | 125 | 20 | 5 | 30-40 | SHR 205MP | SHL 205MP | F6S-418 | BF 04M | NY 2.5 | |
| R/L 153S-2020 × 20 × 5/40-50 | | 44,680 | 49,160 | | | | | | | | | | | | |

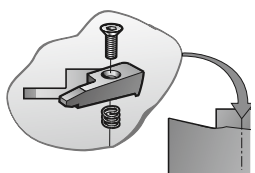

レンチ以外のパーツはホルダに付属しています。

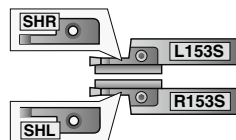

※) 153S ホルダはホルダの勝手 (R153S、L153S) と逆勝手のクランプ (SHL、SHR) が付きます。

| 適用チップ | 型番  | 在庫 | 単価 | | 寸法 (mm) | | | | | | クランプ | | クランプ スクリュー | スプリング | レンチ | |
|---------------------------------|---|--------|----------|----------|---------|-----|-----|----------------|----------------|--------------|----------------|----------------|---|---|---|--|
| | | | R 右勝手 | L 左勝手 | H | B | L | L ₁ | B ₁ | D | L153S 用 SHR | R153S 用 SHL |  |  |  | |
| 5 | R/L 153S-2020 × 20 × 5/50-60 | | 44,680 | 49,160 | | | | | | | | | | | | |
| | R/L 153S-2020 × 20 × 5/60-75 | | 44,680 | 49,160 | | | | | | | | | | | | |
| | R/L 153S-2020 × 20 × 5/75-100 | | 44,680 | 49,160 | | | | | | | | | | | | |
| | R/L 153S-2020 × 20 × 5/100-140 | | 44,680 | 49,160 | 20 | 20 | 125 | 20 | 5 | 50-60 | *) SHR 205MT | *) SHL 205MT | F6S-418 | BF 04M | NY 2.5 | |
| | R/L 153S-2020 × 20 × 5/140-190 | | 44,680 | 49,160 | | | | | | 60-75 | | | | | | |
| | R/L 153S-2020 × 20 × 5/190-300 | | 44,680 | 49,160 | | | | | | 75-100 | | | | | | |
| | R/L 153S-2020 × 20 × 5/300-∞ | | 44,680 | 49,160 | | | | | | 100-140 | | | | | | |
| | R/L 153S-2525 × 12 × 5/30-40 | | 45,890 | 50,480 | | | | | | 140-190 | | | | | | |
| | R/L 153S-2525 × 12 × 5/40-50 | | 45,890 | 50,480 | | | | | | 190-300 | | | | | | |
| | R/L 153S-2525 × 12 × 5/50-60T | | 45,890 | 50,480 | | | | | | 300-∞ | | | | | | |
| | R/L 153S-2525 × 12 × 5/60-75T | | 45,890 | 50,480 | 25 | 25 | 150 | 12 | 5 | 30-40 | *) SHR 135P | *) SHL 135P | | | | |
| | R/L 153S-2525 × 12 × 5/75-100T | | 45,890 | 50,480 | | | | | | 40-50 | | | | | | |
| | R/L 153S-2525 × 12 × 5/100-140T | ○ | 45,890 | 50,480 | | | | | | 50-60 | | | | | | |
| | R/L 153S-2525 × 12 × 5/140-190T | | 45,890 | 50,480 | | | | | | 60-75 | *) SHR 135 | *) SHL 135 | F6S-411 | BF 04M | NY 2.5 | |
| | R/L 153S-2525 × 12 × 5/190-∞ T | ○ | 45,890 | 50,480 | | | | | | 75-100 | | | | | | |
| | R/L 153S-2525 × 20 × 5/30-40 | ○ | 49,510 | 54,470 | | | | | | 100-140 | *) SHR 205MP | *) SHL 205MP | | | | |
| | R/L 153S-2525 × 20 × 5/40-50 | ○ | 49,510 | 54,470 | | | | | | 140-190 | | | | | | |
| | R/L 153S-2525 × 20 × 5/50-60 | ○ | 49,510 | 54,470 | | | | | | 190-300 | | | | | | |
| | R/L 153S-2525 × 20 × 5/60-75 | ○ | 49,510 | 54,470 | 25 | 25 | 150 | 20 | 5 | 300-∞ | *) SHR 205MT | *) SHL 205MT | F6S-418 | BF 04M | NY 2.5 | |
| | R/L 153S-2525 × 20 × 5/75-100 | ○ | 49,510 | 54,470 | | | | | | | | | | | | |
| | R/L 153S-2525 × 20 × 5/100-140 | ○ | 49,510 | 54,470 | | | | | | | | | | | | |
| | R/L 153S-2525 × 20 × 5/140-190 | ○ | 49,510 | 54,470 | | | | | | | | | | | | |
| | R/L 153S-2525 × 20 × 5/190-300 | ○ | 49,510 | 54,470 | | | | | | | | | | | | |
| | R/L 153S-2525 × 20 × 5/300-∞ | ○ | 49,510 | 54,470 | | | | | | | | | | | | |
| | R/L 153S-2525 × 25 × 5/50-60 | | 53,990 | 59,410 | | | | | | | | | | | | |
| | R/L 153S-2525 × 25 × 5/60-75 | | 53,990 | 59,410 | | | | | | | | | | | | |
| | R/L 153S-2525 × 25 × 5/75-100 | ○ | 53,990 | 59,410 | 25 | 25 | 150 | 25 | 5 | 50-60 | *) SHR 255MT | *) SHL 255MT | F6S-418 | BF 04M | NY 2.5 | |
| | R/L 153S-2525 × 25 × 5/100-140 | ○ | 53,990 | 59,410 | | | | | | 60-75 | | | | | | |
| R/L 153S-2525 × 25 × 5/140-190 | ○ | 53,990 | 59,410 | | | | | | 75-100 | | | | | | | |
| R/L 153S-2525 × 25 × 5/190-300 | ○ | 53,990 | 59,410 | | | | | | 100-140 | | | | | | | |
| R/L 153S-2525 × 25 × 5/300-∞ | ○ | 53,990 | 59,410 | | | | | | 140-190 | | | | | | | |
| R/L 153S-3225 × 12 × 5/40-50 | | 47,340 | 52,050 | | | | | | 190-300 | | | | | | | |
| R/L 153S-3225 × 12 × 5/50-60T | | 47,340 | 52,050 | | | | | | 300-∞ | | | | | | | |
| R/L 153S-3225 × 12 × 5/60-75T | | 47,340 | 52,050 | 32 | 25 | 170 | 12 | 5 | 40-50 | *) SHR 135 | *) SHL 135 | F6S-411 | — | NY 2.5 | | |
| R/L 153S-3225 × 12 × 5/75-100T | | 47,340 | 52,050 | | | | | | 50-60 | | | | | | | |
| R/L 153S-3225 × 12 × 5/100-140T | | 47,340 | 52,050 | | | | | | 60-75 | | | | | | | |
| R/L 153S-3225 × 12 × 5/140-190T | | 47,340 | 52,050 | | | | | | 75-100 | | | | | | | |
| R/L 153S-3225 × 12 × 5/190-∞ T | | 47,340 | 52,050 | | | | | | 100-140 | | | | | | | |
| R/L 153S-3225 × 20 × 5/40-50 | | 50,720 | 55,790 | | | | | | 140-190 | | | | | | | |
| R/L 153S-3225 × 20 × 5/50-60 | | 50,720 | 55,790 | | | | | | 190-300 | | | | | | | |
| R/L 153S-3225 × 20 × 5/60-75 | | 50,720 | 55,790 | | | | | | 300-∞ | | | | | | | |
| R/L 153S-3225 × 20 × 5/75-100 | | 50,720 | 55,790 | 32 | 25 | 170 | 20 | 5 | 40-50 | *) SHR 205MT | *) SHL 205MT | F6S-418 | BF 04M | NY 2.5 | | |
| R/L 153S-3225 × 20 × 5/100-140 | | 50,720 | 55,790 | | | | | | 50-60 | | | | | | | |
| R/L 153S-3225 × 20 × 5/140-190 | | 50,720 | 55,790 | | | | | | 60-75 | | | | | | | |
| R/L 153S-3225 × 20 × 5/190-300 | | 50,720 | 55,790 | | | | | | 75-100 | | | | | | | |
| R/L 153S-3225 × 20 × 5/300-∞ | | 50,720 | 55,790 | | | | | | 100-140 | | | | | | | |
| R/L 153S-3225 × 25 × 5/50-60 | | 55,310 | 60,860 | | | | | | 140-190 | | | | | | | |
| R/L 153S-3225 × 25 × 5/60-75 | | 55,310 | 60,860 | 32 | 25 | 170 | 25 | 5 | 190-300 | *) SHR 255MT | *) SHL 255MT | F6S-418 | BF 04M | NY 2.5 | | |
| R/L 153S-3225 × 25 × 5/75-100 | | 55,310 | 60,860 | | | | | | 300-∞ | | | | | | | |
| R/L 153S-3225 × 25 × 5/100-140 | | 55,310 | 60,860 | | | | | | | | | | | | | |

◎：左右両勝手在庫 ○：右勝手のみ在庫 空欄：メーカー（海外）または受注生産

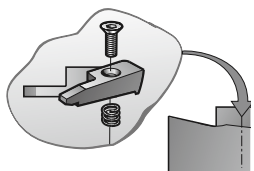

レンチ以外のパーツはホルダに
付属しています。

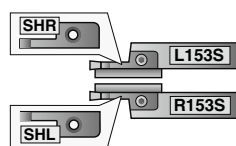

※) 153S ホルダは
ホルダの勝手 (R153S、L153S) と
逆勝手のクランプ (SHL、SHR) が付き
ます。

外径溝入れ
突切り
端面溝入れ
内径溝入れ
シームレス防振
ヌスミ溝入れ
チップ
切削条件表
自動盤工具

153S 端面溝入れ 5-8mm

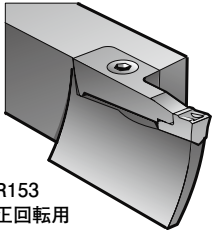

R153
正回転用

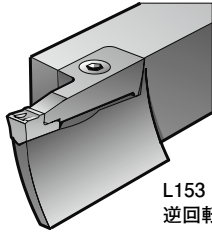

L153
逆回転用

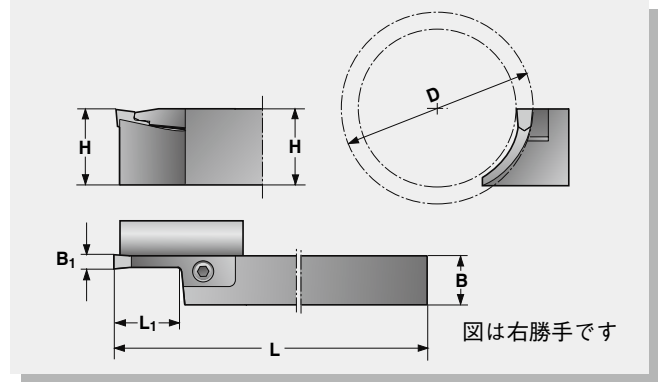

| 適用チップ | 型番 | 在庫 | 単価 | | 寸法 (mm) | | | | | クランプ | | クランプ スクリュー | スプリング | レンチ | |
|-------|--------------------------------|--------|----------|----------|---------|----|-----|----------------|----------------|---------|---------------|---------------|---------|--------|--------|
| | | | R 右勝手 | L 左勝手 | H | B | L | L ₁ | B ₁ | D | L153S用 SHR | R153S用 SHL | | | |
| 5 | R/L 153S-3225 × 25 × 5/140-190 | | 55,310 | 60,860 | 32 | 25 | 170 | 25 | 5 | 140-190 | SHR 255MT | SHL 255MT | F6S-418 | BF 04M | NY 2.5 |
| | R/L 153S-3225 × 25 × 5/190-300 | 55,310 | 60,860 | | | | | | | | | | | | |
| | R/L 153S-3225 × 25 × 5/300-∞ | 55,310 | 60,860 | | | | | | | | | | | | |

チップ幅 6.1mm 端面径φ 40mm 以上

| | | | | | | | | | | | | | | | |
|--------------------------------|---------------------------------|--------|--------|--------|----|----|-----|----|-------|-------|-----------|-----------|---------|--------|--------|
| 6 | R/L 153S-2020 × 12 × 6/40-50 | | 42,390 | 46,610 | 20 | 20 | 125 | 12 | 6-7.5 | 40-50 | SHR 136 | SHL 136 | F6S-411 | — | NY 2.5 |
| | R/L 153S-2020 × 12 × 6/50-60T | 42,390 | 46,610 | | | | | | | | | | | | |
| | R/L 153S-2020 × 12 × 6/60-75T | 42,390 | 46,610 | | | | | | | | | | | | |
| | R/L 153S-2020 × 12 × 6/75-100T | 42,390 | 46,610 | | | | | | | | | | | | |
| | R/L 153S-2020 × 12 × 6/100-140T | 42,390 | 46,610 | | | | | | | | | | | | |
| | R/L 153S-2020 × 12 × 6/140-190T | 42,390 | 46,610 | | | | | | | | | | | | |
| | R/L 153S-2020 × 12 × 6/190-∞ T | 42,390 | 46,610 | | | | | | | | | | | | |
| | R/L 153S-2020 × 20 × 6/40-50 | 44,680 | 49,160 | | | | | | | | | | | | |
| | R/L 153S-2020 × 20 × 6/50-60 | 44,680 | 49,160 | | | | | | | | | | | | |
| | R/L 153S-2020 × 20 × 6/60-75 | 44,680 | 49,160 | | | | | | | | | | | | |
| | R/L 153S-2020 × 20 × 6/75-100 | 44,680 | 49,160 | | | | | | | | | | | | |
| | R/L 153S-2020 × 20 × 6/100-140 | 44,680 | 49,160 | | | | | | | | | | | | |
| R/L 153S-2020 × 20 × 6/140-190 | 44,680 | 49,160 | | | | | | | | | | | | | |
| R/L 153S-2020 × 20 × 6/190-300 | 44,680 | 49,160 | | | | | | | | | | | | | |
| R/L 153S-2020 × 20 × 6/300-∞ | 44,680 | 49,160 | | | | | | | | | | | | | |
| 7 | R/L 153S-2525 × 12 × 6/40-50 | | 45,890 | 50,480 | 25 | 25 | 150 | 12 | 6-7.5 | 40-50 | SHR 136 | SHL 136 | F6S-411 | — | NY 2.5 |
| | R/L 153S-2525 × 12 × 6/50-60T | 45,890 | 50,480 | | | | | | | | | | | | |
| | R/L 153S-2525 × 12 × 6/60-75T | 45,890 | 50,480 | | | | | | | | | | | | |
| | R/L 153S-2525 × 12 × 6/75-100T | 45,890 | 50,480 | | | | | | | | | | | | |
| | R/L 153S-2525 × 12 × 6/100-140T | 45,890 | 50,480 | | | | | | | | | | | | |
| | R/L 153S-2525 × 12 × 6/140-190T | 45,890 | 50,480 | | | | | | | | | | | | |
| | R/L 153S-2525 × 12 × 6/190-∞ T | 45,890 | 50,480 | | | | | | | | | | | | |
| | R/L 153S-2525 × 20 × 6/40-50 | 49,510 | 54,470 | | | | | | | | | | | | |
| | R/L 153S-2525 × 20 × 6/50-60 | 49,510 | 54,470 | | | | | | | | | | | | |
| | R/L 153S-2525 × 20 × 6/60-75 | 49,510 | 54,470 | | | | | | | | | | | | |
| | R/L 153S-2525 × 20 × 6/75-100 | 49,510 | 54,470 | | | | | | | | | | | | |
| | R/L 153S-2525 × 20 × 6/100-140 | 49,510 | 54,470 | | | | | | | | | | | | |
| R/L 153S-2525 × 20 × 6/140-190 | 49,510 | 54,470 | | | | | | | | | | | | | |
| R/L 153S-2525 × 20 × 6/190-300 | 49,510 | 54,470 | | | | | | | | | | | | | |
| R/L 153S-2525 × 20 × 6/300-∞ | 49,510 | 54,470 | | | | | | | | | | | | | |
| 8 | R/L 153S-2525 × 25 × 6/50-60 | ○ | 53,990 | 59,410 | 25 | 25 | 150 | 25 | 6-7.5 | 50-60 | SHR 256MT | SHL 256MT | F6S-418 | BF 04M | NY 2.5 |
| | R/L 153S-2525 × 25 × 6/60-75 | ○ | 53,990 | 59,410 | | | | | | | | | | | |

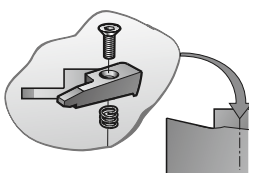

レンチ以外のパーツはホルダに
付属しています。

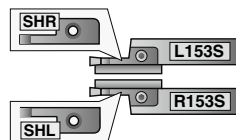

※) 153S ホルダは
ホルダの勝手 (R153S、L153S) と
逆勝手のクランプ (SHL、SHR) が付き
ます。

| 適用チップ | 型番  | 在庫 | 単価 | | 寸法 (mm) | | | | | クランプ | | クランプ スクリュー | スプリング | レンチ | |
|---------------------------------------|---|--------|----------|----------|---------|-----|-----|----------------|----------------|--------------|----------------|----------------|---|---|---|
| | | | R 右勝手 | L 左勝手 | H | B | L | L ₁ | B ₁ | D | L153S 用 SHR | R153S 用 SHL |  |  |  |
| 6 | R/L 153S-2525 × 25 × 6/75-100 | ○ | 53,990 | 59,410 | | | | | | 75-100 | | | | | |
| | R/L 153S-2525 × 25 × 6/100-140 | ○ | 53,990 | 59,410 | | | | | | 100-140 | | | | | |
| | R/L 153S-2525 × 25 × 6/140-190 | ○ | 53,990 | 59,410 | 25 | 25 | 150 | 25 | 6-7.5 | 140-190 | ※) SHR 256MT | ※) SHL 256MT | F6S-418 | BF 04M | NY 2.5 |
| | R/L 153S-2525 × 25 × 6/190-300 | ○ | 53,990 | 59,410 | | | | | | 190-300 | | | | | |
| | R/L 153S-2525 × 25 × 6/300-∞ | ○ | 53,990 | 59,410 | | | | | | 300-∞ | | | | | |
| | R/L 153S-3225 × 12 × 6/40-50 | | 47,340 | 52,050 | | | | | | 40-50 | | | | | |
| | R/L 153S-3225 × 12 × 6/50-60T | | 47,340 | 52,050 | | | | | | 50-60 | | | | | |
| | R/L 153S-3225 × 12 × 6/60-75T | | 47,340 | 52,050 | | | | | | 60-75 | | | | | |
| | R/L 153S-3225 × 12 × 6/75-100T | | 47,340 | 52,050 | 32 | 25 | 170 | 12 | 6-7.5 | 75-100 | ※) SHR 136 | ※) SHL 136 | F6S-411 | — | NY 2.5 |
| | R/L 153S-3225 × 12 × 6/100-140T | | 47,340 | 52,050 | | | | | | 100-140 | | | | | |
| | R/L 153S-3225 × 12 × 6/140-190T | | 47,340 | 52,050 | | | | | | 140-190 | | | | | |
| | R/L 153S-3225 × 12 × 6/190-∞ T | | 47,340 | 52,050 | | | | | | 190-∞ | | | | | |
| | R 153S-3225 × 20 × 6/40-50 | | 50,720 | 55,790 | | | | | | 40-50 | | | | | |
| | R/L 153S-3225 × 20 × 6/50-60 | | 50,720 | 55,790 | | | | | | 50-60 | | | | | |
| | R/L 153S-3225 × 20 × 6/60-75 | | 50,720 | 55,790 | | | | | | 60-75 | | | | | |
| | R/L 153S-3225 × 20 × 6/75-100 | | 50,720 | 55,790 | 32 | 25 | 170 | 20 | 6-7.5 | 75-100 | ※) SHR 206MT | ※) SHL 206MT | F6S-418 | BF 04M | NY 2.5 |
| | R/L 153S-3225 × 20 × 6/100-140 | | 50,720 | 55,790 | | | | | | 100-140 | | | | | |
| | R/L 153S-3225 × 20 × 6/140-190 | | 50,720 | 55,790 | | | | | | 140-190 | | | | | |
| | R/L 153S-3225 × 20 × 6/190-300 | | 50,720 | 55,790 | | | | | | 190-300 | | | | | |
| | R/L 153S-3225 × 20 × 6/300-∞ | | 50,720 | 55,790 | | | | | | 300-∞ | | | | | |
| | R/L 153S-3225 × 25 × 6/50-60 | | 55,310 | 60,860 | | | | | | 50-60 | | | | | |
| | R/L 153S-3225 × 25 × 6/60-75 | | 55,310 | 60,860 | | | | | | 60-75 | | | | | |
| | R/L 153S-3225 × 25 × 6/75-100 | | 55,310 | 60,860 | | | | | | 75-100 | | | | | |
| | R/L 153S-3225 × 25 × 6/100-140 | | 55,310 | 60,860 | 32 | 25 | 170 | 25 | 6-7.5 | 100-140 | ※) SHR 256MT | ※) SHL 256MT | F6S-418 | BF 04M | NY 2.5 |
| R/L 153S-3225 × 25 × 6/140-190 | | 55,310 | 60,860 | | | | | | 140-190 | | | | | | |
| R/L 153S-3225 × 25 × 6/190-300 | | 55,310 | 60,860 | | | | | | 190-300 | | | | | | |
| R/L 153S-3225 × 25 × 6/300-∞ | | 55,310 | 60,860 | | | | | | 300-∞ | | | | | | |
| R/L 153S-3225 × 32 × 6/50-60 | ○ | 60,380 | 66,420 | | | | | | 50-60 | | | | | | |
| R/L 153S-3225 × 32 × 6/60-75 | ○ | 60,380 | 66,420 | | | | | | 60-75 | | | | | | |
| R/L 153S-3225 × 32 × 6/75-100 | ○ | 60,380 | 66,420 | | | | | | 75-100 | | | | | | |
| R/L 153S-3225 × 32 × 6/100-140 | ○ | 60,380 | 66,420 | 32 | 25 | 170 | 32 | 6-7.5 | 100-140 | ※) SHR 326MT | ※) SHL 326MT | F6S-519 | BF 05M | NY 3 | |
| R/L 153S-3225 × 32 × 6/140-190 | ○ | 60,380 | 66,420 | | | | | | 140-190 | | | | | | |
| R/L 153S-3225 × 32 × 6/190-300 | ○ | 60,380 | 66,420 | | | | | | 190-300 | | | | | | |
| R/L 153S-3225 × 32 × 6/300-∞ | ○ | 60,380 | 66,420 | | | | | | 300-∞ | | | | | | |
| R/L 153S-4032 × 32 × 6/140-190 | | 67,140 | 73,900 | | | | | | 140-190 | | | | | | |
| R/L 153S-4032 × 32 × 6/190-300 | | 67,140 | 73,900 | 40 | 32 | 200 | 32 | 6-7.5 | 190-300 | ※) SHR 326MT | ※) SHL 326MT | F6S-519 | BF 05M | NY 3 | |
| R/L 153S-4032 × 32 × 6/300-∞ | | 67,140 | 73,900 | | | | | | 300-∞ | | | | | | |
| チップ幅 8.1 ~ 12.1mm 端面径φ 75mm 以上 | | | | | | | | | | | | | | | |
| 8 | R/L 153S-2525 × 20 × 8/75-100 | | 50,720 | 55,790 | | | | | | 75-100 | | | | | |
| | R/L 153S-2525 × 20 × 8/100-140 | | 50,720 | 55,790 | 25 | 25 | 150 | 20 | 8-9 | 100-140 | ※) SHR 208MT | ※) SHL 208MT | F6S-519 | BF 05M | NY 3 |
| | R/L 153S-2525 × 20 × 8/140-190 | | 50,720 | 55,790 | | | | | | 140-190 | | | | | |
| | R/L 153S-2525 × 20 × 8/190-∞ | | 50,720 | 55,790 | | | | | | 190-∞ | | | | | |
| | R/L 153S-3225 × 20 × 8/75-100 | | 54,470 | 59,900 | | | | | | 75-100 | | | | | |
| | R/L 153S-3225 × 20 × 8/100-140 | | 54,470 | 59,900 | 32 | 25 | 170 | 20 | 8-9 | 100-140 | ※) SHR 208MT | ※) SHL 208MT | F6S-519 | BF 05M | NY 3 |
| | R/L 153S-3225 × 20 × 8/140-190 | | 54,470 | 59,900 | | | | | | 140-190 | | | | | |
| | R/L 153S-3225 × 20 × 8/190-∞ | ○ | 54,470 | 59,900 | | | | | | 190-∞ | | | | | |
| R/L 153S-4032 × 30 × 8/75-100 | | 72,340 | 79,580 | | | | | | 75-100 | | | | | | |
| R/L 153S-4032 × 30 × 8/100-140 | | 72,340 | 79,580 | 40 | 32 | 200 | 30 | 8-9 | 100-140 | ※) SHR 308MT | ※) SHL 308MT | F6S-519 | BF 05M | NY 3 | |
| R/L 153S-4032 × 30 × 8/140-190 | | 72,340 | 79,580 | | | | | | 140-190 | | | | | | |

◎：左右両勝手在庫 ○：右勝手のみ在庫 空欄：メーカー（海外）または受注生産

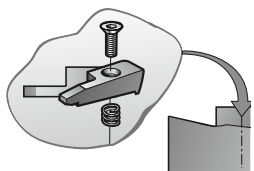

レンチ以外のパーツはホルダに
付属しています。

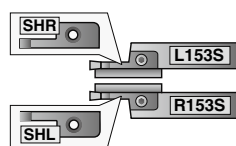

※) 153Sホルダは
ホルダの勝手 (R153S、L153S) と
逆勝手のクランプ (SHL、SHR) が付き
ます。

153S 端面溝入れ 8-12mm

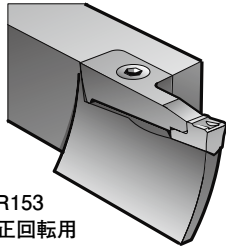

R153
正回転用

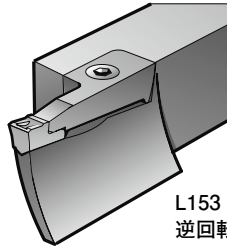

L153
逆回転用

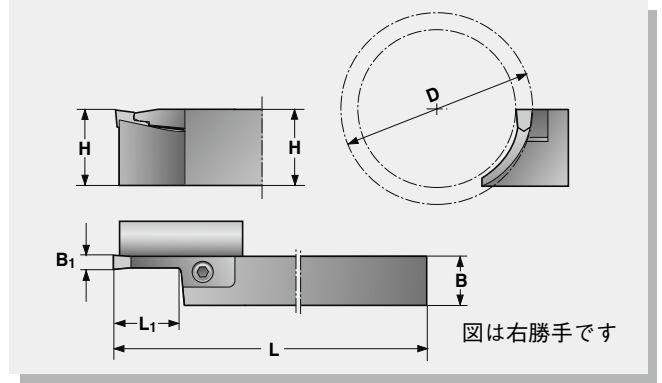

| 適用チップ | 型番 | 在庫 | 単価 | | 寸法 (mm) | | | | | | クランプ | | クランプ スクリュー | スプリング | レンチ |
|-------|-----------------------------------|----|----------|----------|---------|----|-----|----------------|----------------|---------|----------------|----------------|---------------|--------|--------|
| | | | R 右勝手 | L 左勝手 | H | B | L | L ₁ | B ₁ | D | L153S 用 SHR | R153S 用 SHL | | | |
| 8 | R/L 153S-4032 × 30 × 8/190-300 | | 72,340 | 79,580 | 40 | 32 | 200 | 30 | 8-9 | 190-300 | *) SHR 308MT | *) SHL 308MT | F6S-519 | BF 05M | NY 3 |
| | R/L 153S-4032 × 30 × 8/300-∞ | | 72,340 | 79,580 | | | | | | 300-∞ | | | | | |
| | *)R/L 153S-4032 × 50 × 8/140-190 | | 83,210 | 91,530 | | | | | | 140-190 | SHN 8T | | F6S-418 | BF 04T | NY 2.5 |
| | *)R/L 153S-4032 × 50 × 8/190-300 | | 83,210 | 91,530 | 40 | 32 | 200 | 50 | 8-9 | 190-300 | | | | | |
| | *)R/L 153S-4032 × 50 × 8/300-500 | | 83,210 | 91,530 | | | | | | 300-500 | | | | | |
| | *)R/L 153S-4032 × 50 × 8/500-∞ | | 83,210 | 91,530 | | | | | | 500-∞ | | | | | |
| 10 | R/L 153S-3225 × 20 × 10/75-100 | | 54,470 | 59,900 | | | | | | 75-100 | *) SHR 2010MT | *) SHL 2010MT | F6S-519 | BF 05M | NY 3 |
| | R/L 153S-3225 × 20 × 10/100-140 | | 54,470 | 59,900 | 32 | 25 | 170 | 20 | 10-11 | 100-140 | | | | | |
| | R/L 153S-3225 × 20 × 10/140-190 | | 54,470 | 59,900 | | | | | | 140-190 | | | | | |
| | R/L 153S-3225 × 20 × 10/190-∞ | | 54,470 | 59,900 | | | | | | 190-∞ | | | | | |
| | R/L 153S-4032 × 30 × 10/75-100 | | 72,340 | 79,580 | | | | | | 75-100 | *) SHR 3010MT | *) SHL 3010MT | F6S-519 | BF 05M | NY 3 |
| | R/L 153S-4032 × 30 × 10/100-140 | | 72,340 | 79,580 | | | | | | 100-140 | | | | | |
| | R/L 153S-4032 × 30 × 10/140-190 | | 72,340 | 79,580 | 40 | 32 | 200 | 30 | 10-11 | 140-190 | | | | | |
| | R/L 153S-4032 × 30 × 10/190-300 | | 72,340 | 79,580 | | | | | | 190-300 | | | | | |
| | R/L 153S-4032 × 30 × 10/300-∞ | | 72,340 | 79,580 | | | | | 300-∞ | SHN 10T | | F6S-518T | BF 05T | NY 3 | |
| | *)R/L 153S-4032 × 50 × 10/140-190 | | 83,210 | 91,530 | | | | | 140-190 | | | | | | |
| | *)R/L 153S-4032 × 50 × 10/190-300 | | 83,210 | 91,530 | 40 | 32 | 200 | 50 | 10-11 | 190-300 | | | | | |
| | *)R/L 153S-4032 × 50 × 10/300-∞ | | 83,210 | 91,530 | | | | | 300-∞ | | | | | | |
| 12 | R/L 153S-4032 × 30 × 12/75-100 | | 72,340 | 79,580 | | | | | | 75-100 | *) SHR 3012MT | *) SHL 3012MT | F6S-519 | BF 05M | NY 3 |
| | R/L 153S-4032 × 30 × 12/100-140 | | 72,340 | 79,580 | | | | | | 100-140 | | | | | |
| | R/L 153S-4032 × 30 × 12/140-190 | | 72,340 | 79,580 | 40 | 32 | 200 | 30 | 12 | 140-190 | | | | | |
| | R/L 153S-4032 × 30 × 12/190-300 | | 72,340 | 79,580 | | | | | | 190-300 | | | | | |
| | R/L 153S-4032 × 30 × 12/300-∞ | | 72,340 | 79,580 | | | | | | 300-∞ | | | | | |
| | R/L 153S-4032 × 40 × 12/75-100 | | 79,460 | 87,430 | 40 | 32 | 200 | 40 | 12 | 75-100 | *) SHR 4012MT | *) SHL 4012MT | F6S-526 | BF 05M | NY 3 |
| | R/L 153S-4032 × 40 × 12/100-140 | | 79,460 | 87,430 | | | | | | 100-140 | | | | | |
| | *)R/L 153S-4032 × 50 × 12/140-190 | | 83,210 | 91,530 | | | | | | 140-190 | SHN 12T | | F6S-519 | BF 05T | NY 3 |
| | *)R/L 153S-4032 × 50 × 12/190-300 | | 83,210 | 91,530 | 40 | 32 | 200 | 50 | 12 | 190-300 | | | | | |
| | *)R/L 153S-4032 × 50 × 12/300-∞ | | 83,210 | 91,530 | | | | | | 300-∞ | | | | | |
| | *)R/L 153S-5040 × 50 × 12/140-190 | | 受注生産 | | | | | | 140-190 | SHN 12T | | F6S-519 | BF 05T | NY 3 | |
| | *)R/L 153S-5040 × 50 × 12/190-300 | | | | | | | | 190-300 | | | | | | |
| | *)R/L 153S-5040 × 50 × 12/300-∞ | | | | | | | | 300-∞ | | | | | | |

注文例：R153S-2020 × 12 × 4/50-60…2 本

◎：左右両勝手在庫 ○：右勝手のみ在庫 空欄：メーカー（海外）または受注生産

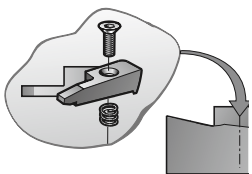

レンチ以外のパーツはホルダに
付属しています。

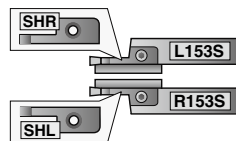

※) 153S ホルダは
ホルダの勝手 (R153S、L153S) と
逆勝手のクランプ (SHL、SHR) が付き
ます。

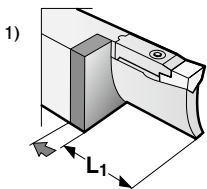

1) ホルダを修正することにより、
より深い切込が可能です。