

152S 端面溝入れ 3-4mm

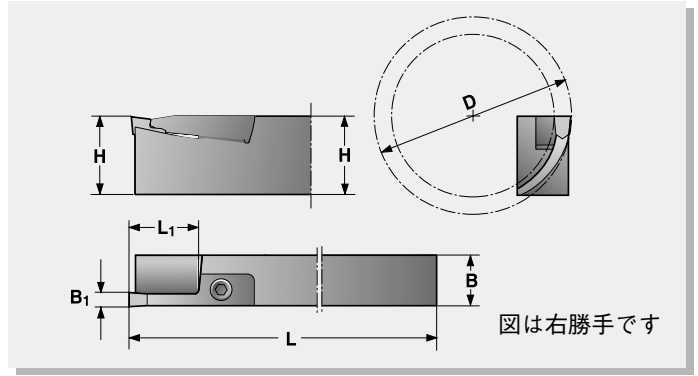

適用チップ	型番		在庫	単価		寸法 (mm)					クランプ		クランプ スクリュー	スプリング	レンチ
	L152S	R152S		R 右勝手	L 左勝手	H	B	L	L1	B1	D	R152S 用 SHR	L152S 用 SHL		

チップ幅 3.0 (3.2) mm 端面径φ 20mm 以上

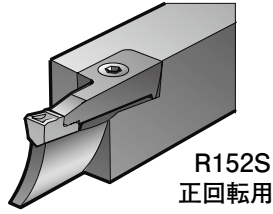
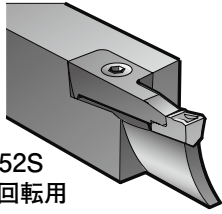

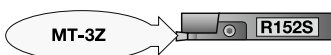

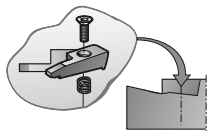

※	R/L 152S-1616 × 12 × 3/20-23	○	33,090	36,470						20-23					
※	R/L 152S-1616 × 12 × 3/23-26	○	33,090	36,470						23-26	SHR 133Z	SHL 133Z			
※	R/L 152S-1616 × 12 × 3/26-30	○	33,090	36,470	16	16	110	12	3	26-30			F6S-411	—	NY2.5
	R/L 152S-1616 × 12 × 3/30-35	○	33,090	36,470						30-35	SHR 133P	SHL 133P			
	R/L 152S-1616 × 12 × 3/35-40	○	33,090	36,470						35-40					
	R/L 152S-1616 × 12 × 3/40-50	○	33,090	36,470						40-50	SHR 133	SHL 133			
※	R/L 152S-2020 × 12 × 3/20-23	○	33,090	36,470						20-23					
※	R/L 152S-2020 × 12 × 3/23-26	○	33,090	36,470						23-26	SHR 133Z	SHL 133Z			
※	R/L 152S-2020 × 12 × 3/26-30	○	33,090	36,470						26-30					
	R/L 152S-2020 × 12 × 3/30-35	○	33,090	36,470						30-35	SHR 133P	SHL 133P			
	R/L 152S-2020 × 12 × 3/35-40	○	33,090	36,470						35-40					
	R/L 152S-2020 × 12 × 3/40-50	○	33,090	36,470						40-50					
	R/L 152S-2020 × 12 × 3/50-60T	○	33,090	36,470						50-60					
	R/L 152S-2020 × 12 × 3/60-75T	○	33,090	36,470	20	20	125	12	3	60-75			F6S-411	—	NY2.5
	R/L 152S-2020 × 12 × 3/75-100T	○	33,090	36,470						75-100					
	R/L 152S-2020 × 12 × 3/100-140T	○	33,090	36,470						100-140	SHR 133	SHL 133			
	R/L 152S-2020 × 12 × 3/140-190T	○	33,090	36,470						140-190					
	R/L 152S-2020 × 12 × 3/190-300T	○	33,090	36,470						190-300					
3	R/L 152S-2020 × 12 × 3/300-500T	○	33,090	36,470						300-500					
	R/L 152S-2020 × 12 × 3/500-∞ T	○	33,090	36,470						500-∞					
※	R/L 152S-2525 × 12 × 3/20-23	○	35,870	39,500						20-23					
※	R/L 152S-2525 × 12 × 3/23-26	○	35,870	39,500						23-26	SHR 133Z	SHL 133Z			
※	R/L 152S-2525 × 12 × 3/26-30	○	35,870	39,500						26-30					
	R/L 152S-2525 × 12 × 3/30-35	○	35,870	39,500						30-35	SHR 133P	SHL 133P			
	R/L 152S-2525 × 12 × 3/35-40	○	35,870	39,500						35-40					
	R/L 152S-2525 × 12 × 3/40-50	○	35,870	39,500						40-50					
	R/L 152S-2525 × 12 × 3/50-60T	◎	35,870	39,500						50-60					
	R/L 152S-2525 × 12 × 3/60-75T	○	35,870	39,500	25	25	150	12	3	60-75			F6S-411	—	NY2.5
	R/L 152S-2525 × 12 × 3/75-100T	○	35,870	39,500						75-100					
	R/L 152S-2525 × 12 × 3/100-140T	○	35,870	39,500						100-140	SHR 133	SHL 133			
	R/L 152S-2525 × 12 × 3/140-190T	○	35,870	39,500						140-190					
	R/L 152S-2525 × 12 × 3/190-300T	○	35,870	39,500						190-300					
	R/L 152S-2525 × 12 × 3/300-500T	○	35,870	39,500						300-500					
	R/L 152S-2525 × 12 × 3/500-∞ T	○	35,870	39,500						500-∞					



※ D 寸法 (溝外径) が、20-23、23-26、26-30 のホルダには専用チップ MT-3Z (P71) を使用してください。

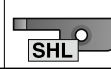

レンチ以外のパーツはホルダに付属しています。

適用チップ	型番  	単価		寸法 (mm)						クランプ		クランプ スクリュー	スプリング	レンチ		
		在庫	R 右勝手	L 左勝手	H	B	L	L ₁	B ₁	D	R152S 用 	L152S 用 				
3	R/L 152S-3225 × 12 × 3/50-60T	○	37,560	41,430	32	25	170	12	3	50-60	SHR 133	SHL 133	F6S-411	—	NY 2.5	
	R/L 152S-3225 × 12 × 3/60-75T	○	37,560	41,430												60-75
	R/L 152S-3225 × 12 × 3/75-100T	○	37,560	41,430												75-100
	R/L 152S-3225 × 12 × 3/100-140T	○	37,560	41,430												100-140
	R/L 152S-3225 × 12 × 3/140-190T	○	37,560	41,430												140-190
	R/L 152S-3225 × 12 × 3/190-300T	○	37,560	41,430												190-300
	R/L 152S-3225 × 12 × 3/300-500T	○	37,560	41,430												300-500
	R/L 152S-3225 × 12 × 3/500-∞ T	○	37,560	41,430												500-∞
チップ幅 4.0 (4.1) mm 端面径φ 30mm 以上																
4	R/L 152S-2020 × 12 × 4/30-40	○	33,090	36,470	20	20	125	12	4-4.5	30-40	SHR 134P	SHL 134P	F6S-411	—	NY 2.5	
	R/L 152S-2020 × 12 × 4/40-50	○	33,090	36,470						40-50						
	R/L 152S-2020 × 12 × 4/50-60T	○	33,090	36,470						50-60						
	R/L 152S-2020 × 12 × 4/60-75T	○	33,090	36,470						60-75						
	R/L 152S-2020 × 12 × 4/75-100T	○	33,090	36,470						75-100						
	R/L 152S-2020 × 12 × 4/100-140T	○	33,090	36,470						100-140						
	R/L 152S-2020 × 12 × 4/140-190T	○	33,090	36,470						140-190						
	R/L 152S-2020 × 12 × 4/190-∞ T	○	33,090	36,470						190-∞						
	R/L 152S-2020 × 20 × 4/30-35	○	35,020	38,530	20	20	125	20	4-4.5	30-35	SHR 204MP	SHL204MP	F6S-418	BF 04M	NY 2.5	
	R/L 152S-2020 × 20 × 4/35-40	○	35,020	38,530						35-40						
	R/L 152S-2020 × 20 × 4/40-50	○	35,020	38,530						40-50						
	R/L 152S-2020 × 20 × 4/50-60	○	35,020	38,530						50-60						
	R/L 152S-2020 × 20 × 4/60-75	○	35,020	38,530						60-75						
	R/L 152S-2020 × 20 × 4/75-100	○	35,020	38,530						75-100						
	R/L 152S-2020 × 20 × 4/100-140	○	35,020	38,530						100-140						
	R/L 152S-2020 × 20 × 4/140-190	○	35,020	38,530						140-190						
R/L 152S-2020 × 20 × 4/190-300	○	35,020	38,530	190-300												
R/L 152S-2020 × 20 × 4/300-∞	○	35,020	38,530	300-∞												
R/L 152S-2525 × 12 × 4/30-40	○	35,870	39,500	25	25	150	12	4-4.5	30-40	SHR 134P	SHL 134P	F6S-411	—	NY 2.5		
R/L 152S-2525 × 12 × 4/40-50	○	35,870	39,500						40-50							
R/L 152S-2525 × 12 × 4/50-60T	○	35,870	39,500						50-60							
R/L 152S-2525 × 12 × 4/60-75T	○	35,870	39,500						60-75							
R/L 152S-2525 × 12 × 4/75-100T	○	35,870	39,500						75-100							
R/L 152S-2525 × 12 × 4/100-140T	○	35,870	39,500						100-140							
R/L 152S-2525 × 12 × 4/140-190T	○	35,870	39,500						140-190							
R/L 152S-2525 × 12 × 4/190-∞ T	○	35,870	39,500						190-∞							
R/L 152S-2525 × 20 × 4/30-35	○	38,770	42,750	25	25	150	20	4-4.5	30-35	SHR 204MP	SHL 204MP	F6S-418	BF 04M	NY 2.5		
R/L 152S-2525 × 20 × 4/35-40	○	38,770	42,750						35-40							
R/L 152S-2525 × 20 × 4/40-50	○	38,770	42,750						40-50							
R/L 152S-2525 × 20 × 4/50-60	○	38,770	42,750						50-60							
R/L 152S-2525 × 20 × 4/60-75	○	38,770	42,750						60-75							
R/L 152S-2525 × 20 × 4/75-100	○	38,770	42,750						75-100							
R/L 152S-2525 × 20 × 4/100-140	◎	38,770	42,750						100-140							
R/L 152S-2525 × 20 × 4/140-190	○	38,770	42,750						140-190							
R/L 152S-2525 × 20 × 4/190-300	○	38,770	42,750	190-300												
R/L 152S-2525 × 20 × 4/300-∞	○	38,770	42,750	300-∞												
R/L 152S-2525 × 25 × 4/50-60	○	39,850	43,840	25	25	150	25	4-4.5	50-60	SHR 254MT	SHL 254MT	F6S-418	BF 04M	NY 2.5		
R/L 152S-2525 × 25 × 4/60-75	○	39,850	43,840						60-75							
R/L 152S-2525 × 25 × 4/75-100	○	39,850	43,840						75-100							

◎：左右両勝手在庫 ○：右勝手のみ在庫 空欄：メーカー（海外）または受注生産

外径溝入れ

突切り

端面溝入れ

内径溝入れ

シームレス防振

ヌスミ溝入れ

チップ

切削条件表

自動盤工具

152S 端面溝入れ 4-5mm

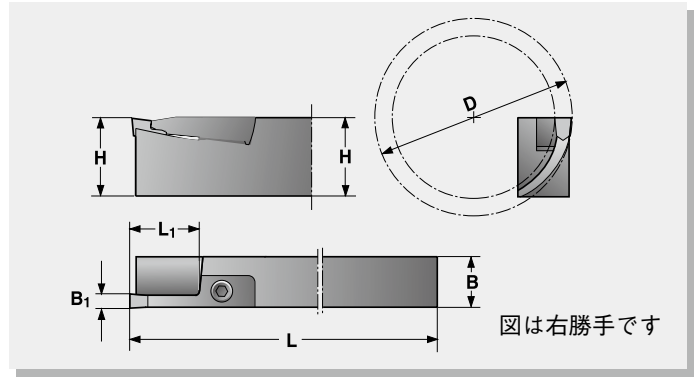
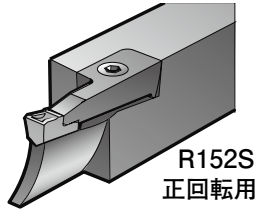
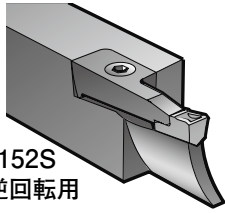

適用チップ	型番 	在庫	単価		寸法 (mm)					クランプ		クランプ スクリュー	スプリング	レンチ	
			R 右勝手	L 左勝手	H	B	L	L ₁	B ₁	D	R152S 用 				L152S 用
4	R/L 152S-2525 × 25 × 4/100-140	○	39,850	43,840	25	25	150	25	4-4.5	100-140	SHR 254MT	SHL 254MT	F6S-418	BF 04M	NY 2.5
	R/L 152S-2525 × 25 × 4/140-190	○	39,850	43,840											
	R/L 152S-2525 × 25 × 4/190-300	○	39,850	43,840											
	R/L 152S-2525 × 25 × 4/300-∞	○	39,850	43,840											
	R/L 152S-3225 × 12 × 4/40-50	○	37,560	41,430	32	25	170	12	4-4.5	40-50	SHR 134	SHL 134	F6S-411	—	NY 2.5
	R/L 152S-3225 × 12 × 4/50-60T		37,560	41,430											
	R/L 152S-3225 × 12 × 4/60-75T		37,560	41,430											
	R/L 152S-3225 × 12 × 4/75-100T		37,560	41,430											
	R/L 152S-3225 × 12 × 4/100-140T		37,560	41,430											
	R/L 152S-3225 × 12 × 4/140-190T		37,560	41,430											
	R/L 152S-3225 × 12 × 4/190-∞ T		37,560	41,430											
	R/L 152S-3225 × 20 × 4/50-60		39,850	43,840											
	R/L 152S-3225 × 20 × 4/60-75	39,850	43,840												
	R/L 152S-3225 × 20 × 4/75-100	39,850	43,840												
	R/L 152S-3225 × 20 × 4/100-140	○	39,850	43,840	32	25	170	20	4-4.5	100-140	SHR 204MT	SHL 204MT	F6S-418	—	NY 2.5
	R/L 152S-3225 × 20 × 4/140-190		39,850	43,840											
R/L 152S-3225 × 20 × 4/190-300	39,850		43,840												
R/L 152S-3225 × 20 × 4/300-∞	39,850		43,840												
R/L 152S-3225 × 25 × 4/50-60	○	40,820	44,810	32	25	170	25	4-4.5	50-60	SHR 254MT	SHL 254MT	F6S-418	BF 04M	NY 2.5	
R/L 152S-3225 × 25 × 4/60-75		40,820	44,810												
R/L 152S-3225 × 25 × 4/75-100		40,820	44,810												
R/L 152S-3225 × 25 × 4/100-140		40,820	44,810												
R/L 152S-3225 × 25 × 4/140-190		40,820	44,810												
R/L 152S-3225 × 25 × 4/190-300		40,820	44,810												
R/L 152S-3225 × 25 × 4/300-∞		40,820	44,810												
チップ幅 5.1mm 端面径φ 30mm 以上															
5	R/L 152S-2020 × 12 × 5/30-40	○	33,090	36,470	20	20	125	12	5	30-40	SHR 135P	SHL 135P	F6S-411	—	NY 2.5
	R/L 152S-2020 × 12 × 5/40-50		33,090	36,470											
	R/L 152S-2020 × 12 × 5/50-60T		33,090	36,470											
	R/L 152S-2020 × 12 × 5/60-75T		33,090	36,470											
	R/L 152S-2020 × 12 × 5/75-100T		33,090	36,470											
	R/L 152S-2020 × 12 × 5/100-140T		33,090	36,470											
	R/L 152S-2020 × 12 × 5/140-190T		33,090	36,470											
	R/L 152S-2020 × 12 × 5/190-∞ T		33,090	36,470											
	R/L 152S-2020 × 20 × 5/30-40	35,020	38,530												
	R/L 152S-2020 × 20 × 5/40-50	35,020	38,530												

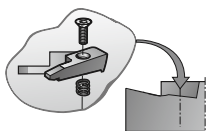

レンチ以外のパーツはホルダに付属しています。

適用チップ	型番  	在庫	単価		寸法 (mm)						クランプ		クランプ スクリュー	スプリング	レンチ	
			R 右勝手	L 左勝手	H	B	L	L ₁	B ₁	D	R152S 用 	L152S 用 				
5	R/L 152S-2020 × 20 × 5/50-60	○	35,020	38,530	20	20	125	20	5	50-60	SHR 205MT	SHL 205MT	F6S-418	BF 04M	NY 2.5	
	R/L 152S-2020 × 20 × 5/60-75		35,020	38,530												60-75
	R/L 152S-2020 × 20 × 5/75-100		35,020	38,530												75-100
	R/L 152S-2020 × 20 × 5/100-140		35,020	38,530												100-140
	R/L 152S-2020 × 20 × 5/140-190		35,020	38,530												140-190
	R/L 152S-2020 × 20 × 5/190-300		35,020	38,530												190-300
	R/L 152S-2020 × 20 × 5/300-∞		35,020	38,530												300-∞
	R/L 152S-2525 × 12 × 5/30-40	○	35,870	39,500	25	25	150	12	5	30-40	SHR 135P	SHL 135P	F6S-411	BF 04M	NY 2.5	
	R/L 152S-2525 × 12 × 5/40-50		35,870	39,500												40-50
	R/L 152S-2525 × 12 × 5/50-60T		35,870	39,500												50-60
	R/L 152S-2525 × 12 × 5/60-75T		35,870	39,500												60-75
	R/L 152S-2525 × 12 × 5/75-100T		35,870	39,500												75-100
	R/L 152S-2525 × 12 × 5/100-140T		35,870	39,500												100-140
	R/L 152S-2525 × 12 × 5/140-190T		35,870	39,500												140-190
	R/L 152S-2525 × 12 × 5/190-∞ T	35,870	39,500	190-∞												
	R/L 152S-2525 × 20 × 5/30-40	○	38,770	42,750	25	25	150	20	5	30-40	SHR 205MP	SHL 205MP	F6S-418	BF 04M	NY 2.5	
	R/L 152S-2525 × 20 × 5/40-50		38,770	42,750												40-50
	R/L 152S-2525 × 20 × 5/50-60		38,770	42,750												50-60
	R/L 152S-2525 × 20 × 5/60-75		38,770	42,750												60-75
	R/L 152S-2525 × 20 × 5/75-100		38,770	42,750												75-100
	R/L 152S-2525 × 20 × 5/100-140		38,770	42,750												100-140
	R/L 152S-2525 × 20 × 5/140-190		38,770	42,750												140-190
	R/L 152S-2525 × 20 × 5/190-300	38,770	42,750	190-300												
	R/L 152S-2525 × 20 × 5/300-∞	38,770	42,750	300-∞												
	R/L 152S-2525 × 25 × 5/50-60	○	39,850	43,840	25	25	150	25	5	50-60	SHR 255MT	SHL 255MT	F6S-418	BF 04M	NY 2.5	
	R/L 152S-2525 × 25 × 5/60-75		39,850	43,840												60-75
	R/L 152S-2525 × 25 × 5/75-100		39,850	43,840												75-100
	R/L 152S-2525 × 25 × 5/100-140		39,850	43,840												100-140
R/L 152S-2525 × 25 × 5/140-190	39,850		43,840	140-190												
R/L 152S-2525 × 25 × 5/190-300	39,850		43,840	190-300												
R/L 152S-2525 × 25 × 5/300-∞	39,850		43,840	300-∞												
R/L 152S-3225 × 12 × 5/40-50	○	37,560	41,430	32	25	170	12	5	40-50	SHR 135	SHL 135	F6S-411	-	NY 2.5		
R/L 152S-3225 × 12 × 5/50-60T		37,560	41,430												50-60	
R/L 152S-3225 × 12 × 5/60-75T		37,560	41,430												60-75	
R/L 152S-3225 × 12 × 5/75-100T		37,560	41,430												75-100	
R/L 152S-3225 × 12 × 5/100-140T		37,560	41,430												100-140	
R/L 152S-3225 × 12 × 5/140-190T		37,560	41,430												140-190	
R/L 152S-3225 × 12 × 5/190-∞ T		37,560	41,430												190-∞	
R/L 152S-3225 × 20 × 5/40-50	○	39,850	43,840	32	25	170	20	5	40-50	SHR 205MT	SHL 205MT	F6S-418	BF 04M	NY 2.5		
R/L 152S-3225 × 20 × 5/50-60		39,850	43,840												50-60	
R/L 152S-3225 × 20 × 5/60-75		39,850	43,840												60-75	
R/L 152S-3225 × 20 × 5/75-100		39,850	43,840												75-100	
R/L 152S-3225 × 20 × 5/100-140		39,850	43,840												100-140	
R/L 152S-3225 × 20 × 5/140-190		39,850	43,840												140-190	
R/L 152S-3225 × 20 × 5/190-300		39,850	43,840												190-300	
R/L 152S-3225 × 20 × 5/300-∞	39,850	43,840	300-∞													
R/L 152S-3225 × 25 × 5/50-60	○	40,820	44,810	32	25	170	25	5	50-60	SHR 255MT	SHL 255MT	F6S-418	BF 04M	NY 2.5		
R/L 152S-3225 × 25 × 5/60-75		40,820	44,810												60-75	
R/L 152S-3225 × 25 × 5/75-100		40,820	44,810												75-100	
R/L 152S-3225 × 25 × 5/100-140		40,820	44,810												100-140	

◎：左右両勝手在庫 ○：右勝手のみ在庫 空欄：メーカー（海外）または受注生産

外径溝入れ

突切り

端面溝入れ

内径溝入れ

シームレス防振

ヌスミ溝入れ

チップ

切削条件表

自動盤工具



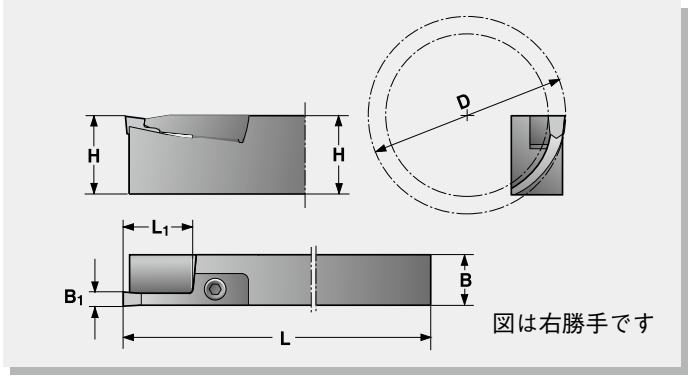
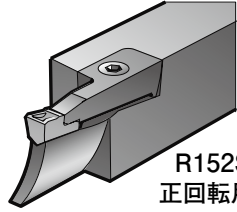
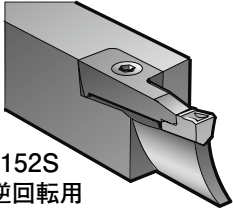

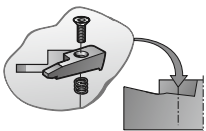

152S 端面溝入れ 5-8mm



適用チップ	型番	在庫	単価		寸法 (mm)					クランプ		クランプ スクリュー	スプリング	レンチ		
			R 右勝手	L 左勝手	H	B	L	L ₁	B ₁	D	R152S 用 SHR				L152S 用 SHL	
5	R/L 152S-3225 × 25 × 5/140-190	○	40,820	44,810	32	25	170	25	5	140-190	SHR 255MT	SHL 255MT	F6S-418	BF 04M	NY 2.5	
	R/L 152S-3225 × 25 × 5/190-300		40,820	44,810												300-∞
	R/L 152S-3225 × 25 × 5/300-∞		40,820	44,810												
チップ幅 6.1mm 端面径φ 40mm 以上																
6	R/L 152S-2020 × 12 × 6/40-50	○	33,090	36,470	20	20	125	12	6-7.5	40-50	SHR 136	SHL 136	F6S-411	—	NY 2.5	
	R/L 152S-2020 × 12 × 6/50-60T		33,090	36,470												75-100
	R/L 152S-2020 × 12 × 6/60-75T		33,090	36,470												
	R/L 152S-2020 × 12 × 6/75-100T		33,090	36,470												140-190
	R/L 152S-2020 × 12 × 6/100-140T		33,090	36,470												
	R/L 152S-2020 × 12 × 6/140-190T		33,090	36,470												40-50
	R/L 152S-2020 × 12 × 6/190-∞ T		33,090	36,470												
	R/L 152S-2020 × 20 × 6/40-50		35,020	38,530												60-75
	R/L 152S-2020 × 20 × 6/50-60		35,020	38,530												
	R/L 152S-2020 × 20 × 6/60-75		35,020	38,530												100-140
	R/L 152S-2020 × 20 × 6/75-100		35,020	38,530												
	R/L 152S-2020 × 20 × 6/100-140		35,020	38,530												190-300
	R/L 152S-2020 × 20 × 6/140-190		35,020	38,530												
	R/L 152S-2020 × 20 × 6/190-300		35,020	38,530												40-50
R/L 152S-2020 × 20 × 6/300-∞	35,020	38,530	50-60													
R/L 152S-2525 × 12 × 6/40-50	35,870	39,500		60-75												
R/L 152S-2525 × 12 × 6/50-60T	35,870	39,500	75-100													
R/L 152S-2525 × 12 × 6/60-75T	35,870	39,500		100-140												
R/L 152S-2525 × 12 × 6/75-100T	35,870	39,500	140-190													
R/L 152S-2525 × 12 × 6/100-140T	35,870	39,500		190-∞												
R/L 152S-2525 × 12 × 6/140-190T	35,870	39,500	40-50													
R/L 152S-2525 × 12 × 6/190-∞ T	35,870	39,500		50-60												
R/L 152S-2525 × 20 × 6/40-50	38,770	42,750	60-75													
R/L 152S-2525 × 20 × 6/50-60	38,770	42,750		75-100												
R/L 152S-2525 × 20 × 6/60-75	38,770	42,750	100-140													
R/L 152S-2525 × 20 × 6/75-100	38,770	42,750		140-190												
R/L 152S-2525 × 20 × 6/100-140	38,770	42,750	190-300													
R/L 152S-2525 × 20 × 6/140-190	38,770	42,750		300-∞												
R/L 152S-2525 × 20 × 6/190-300	38,770	42,750	40-50													
R/L 152S-2525 × 20 × 6/300-∞	38,770	42,750		50-60												
R/L 152S-2525 × 25 × 6/50-60	39,850	43,840	60-75													
R/L 152S-2525 × 25 × 6/60-75	39,850	43,840		SHR 256MT												
			SHL 256MT													
				F6S-418												
			BF 04M													
				NY 2.5												



レンチ以外のパーツはホルダに付属しています。

適用チップ	型番 	在庫	単価		寸法 (mm)						クランプ		クランプ スクリュー	スプリング	レンチ		
			R 右勝手	L 左勝手	H	B	L	L1	B1	D	R152S 用 	L152S 用 					
6	R/L 152S-2525 × 25 × 6/75-100	○	39,850	43,840							75-100						
	R/L 152S-2525 × 25 × 6/100-140	○	39,850	43,840							100-140						
	R/L 152S-2525 × 25 × 6/140-190		39,850	43,840	25	25	150	25	6-7.5		140-190	SHR 256MT	SHL 256MT	F6S-418	BF 04M	NY 2.5	
	R/L 152S-2525 × 25 × 6/190-300		39,850	43,840							190-300						
	R/L 152S-2525 × 25 × 6/300-∞		39,850	43,840							300-∞						
	R/L 152S-3225 × 12 × 6/40-50		37,560	41,430							40-50						
	R/L 152S-3225 × 12 × 6/50-60T		37,560	41,430							50-60						
	R/L 152S-3225 × 12 × 6/60-75T		37,560	41,430							60-75						
	R/L 152S-3225 × 12 × 6/75-100T		37,560	41,430	32	25	170	12	6-7.5		75-100	SHR 136	SHL 136	F6S-411	—	NY 2.5	
	R/L 152S-3225 × 12 × 6/100-140T		37,560	41,430							100-140						
	R/L 152S-3225 × 12 × 6/140-190T		37,560	41,430							140-190						
	R/L 152S-3225 × 12 × 6/190-∞ T		37,560	41,430							190-∞						
	R 152S-3225 × 20 × 6/40-50		39,850	—							40-50						
	R/L 152S-3225 × 20 × 6/50-60		39,850	43,840							50-60						
	R/L 152S-3225 × 20 × 6/60-75		39,850	43,840							60-75						
	R/L 152S-3225 × 20 × 6/75-100	○	39,850	43,840	32	25	170	20	6-7.5		75-100	SHR 206MT	SHL 206MT	F6S-418	BF 04M	NY 2.5	
	R/L 152S-3225 × 20 × 6/100-140		39,850	43,840							100-140						
	R/L 152S-3225 × 20 × 6/140-190		39,850	43,840							140-190						
	R/L 152S-3225 × 20 × 6/190-300		39,850	43,840							190-300						
	R/L 152S-3225 × 20 × 6/300-∞	○	39,850	43,840							300-∞						
	R/L 152S-3225 × 25 × 6/50-60		40,820	44,810							50-60						
	R/L 152S-3225 × 25 × 6/60-75		40,820	44,810							60-75						
	R/L 152S-3225 × 25 × 6/75-100		40,820	44,810							75-100						
	R/L 152S-3225 × 25 × 6/100-140		40,820	44,810	32	25	170	25	6-7.5		100-140	SHR 256MT	SHL 256MT	F6S-418	BF 04M	NY 2.5	
R/L 152S-3225 × 25 × 6/140-190		40,820	44,810							140-190							
R/L 152S-3225 × 25 × 6/190-300		40,820	44,810							190-300							
R/L 152S-3225 × 25 × 6/300-∞		40,820	44,810							300-∞							
R/L 152S-3225 × 32 × 6/50-60	○	41,910	46,130							50-60							
R/L 152S-3225 × 32 × 6/60-75	○	41,910	46,130							60-75							
R/L 152S-3225 × 32 × 6/75-100	○	41,910	46,130							75-100							
R/L 152S-3225 × 32 × 6/100-140	○	41,910	46,130	32	25	170	32	6-7.5		100-140	SHR 326MT	SHL 326MT	F6S-519	BF 05M	NY 3		
R/L 152S-3225 × 32 × 6/140-190	○	41,910	46,130							140-190							
R/L 152S-3225 × 32 × 6/190-300	○	41,910	46,130							190-300							
R/L 152S-3225 × 32 × 6/300-∞	○	41,910	46,130							300-∞							
R/L 152S-4032 × 32 × 6/140-190		59,060	64,970							140-190							
R/L 152S-4032 × 32 × 6/190-300		59,060	64,970	40	32	200	32	6-7.5		190-300	SHR 326MT	SHL 326MT	F6S-519	BF 05M	NY 3		
R/L 152S-4032 × 32 × 6/300-∞		59,060	64,970							300-∞							
チップ幅 8.1 ~ 12.1mm 端面径φ 75mm 以上																	
8	R/L 152S-2525 × 20 × 8/75-100		39,850	43,840							75-100						
	R/L 152S-2525 × 20 × 8/100-140		39,850	43,840	25	25	150	20	8-9		100-140	SHR 208MT	SHL 208MT	F6S-519	BF 05M	NY 3	
	R/L 152S-2525 × 20 × 8/140-190		39,850	43,840							140-190						
	R/L 152S-2525 × 20 × 8/190-∞		39,850	43,840							190-∞						
	R/L 152S-3225 × 20 × 8/75-100		40,820	44,810							75-100						
	R/L 152S-3225 × 20 × 8/100-140		40,820	44,810	32	25	170	20	8-9		100-140	SHR 208MT	SHL 208MT	F6S-519	BF 05M	NY 3	
	R/L 152S-3225 × 20 × 8/140-190		40,820	44,810							140-190						
	R/L 152S-3225 × 20 × 8/190-∞		40,820	44,810							190-∞						
	R/L 152S-4032 × 30 × 8/75-100		57,370	63,040							75-100						
R/L 152S-4032 × 30 × 8/100-140		57,370	63,040	40	32	200	30	8-9		100-140	SHR 308MT	SHL 308MT	F6S-519	BF 05M	NY 3		
R/L 152S-4032 × 30 × 8/140-190		57,370	63,040							140-190							

◎：左右両勝手が在庫 ○：右勝手のみ在庫 空欄：メーカー（海外）または受注生産

152S 端面溝入れ 8-12mm

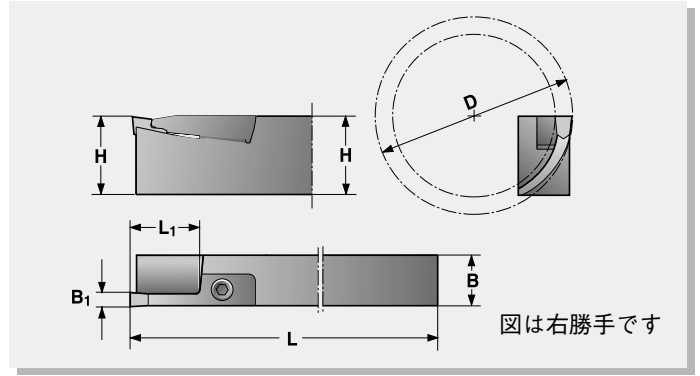
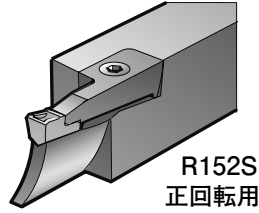
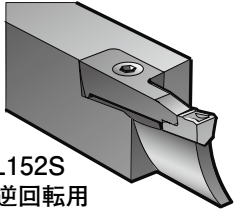

適用チップ	型番	在庫	単価		寸法 (mm)					クランプ		クランプ スクリュー	スプリング	レンチ											
			R 右勝手	L 左勝手	H	B	L	L1	B1	D	R152S 用 SHR				L152S 用 SHL										
8	R/L 152S-4032 × 30 × 8/190-300		57,370	63,040	40	32	200	30	8-9	190-300	SHR 308MT	SHL 308MT	F6S-519	BF 05M	NY 3										
	R/L 152S-4032 × 30 × 8/300-∞		57,370	63,040												40	32	200	50	8-9	140-190	SHN 8T	F6S-418	BF 04T	NY 2.5
	¹⁾ R/L 152S-4032 × 50 × 8/140-190	○	67,870	74,630																					
	¹⁾ R/L 152S-4032 × 50 × 8/190-300	○	67,870	74,630																					
	¹⁾ R/L 152S-4032 × 50 × 8/300-500	○	67,870	74,630																					
¹⁾ R/L 152S-4032 × 50 × 8/500-∞	○	67,870	74,630																						
10	R/L 152S-3225 × 20 × 10/75-100		40,820	44,810	32	25	170	20	10-11	75-100	SHR 2010MT	SHL 2010MT	F6S-519	BF 05M	NY 3										
	R/L 152S-3225 × 20 × 10/100-140		40,820	44,810																					
	R/L 152S-3225 × 20 × 10/140-190		40,820	44,810																					
	R/L 152S-3225 × 20 × 10/190-∞		40,820	44,810																					
	R/L 152S-4032 × 30 × 10/75-100		57,370	63,040	40	32	200	30	10-11	75-100	SHR 3010MT	SHL 3010MT	F6S-519	BF 05M	NY 3										
	R/L 152S-4032 × 30 × 10/100-140		57,370	63,040																					
	R/L 152S-4032 × 30 × 10/140-190		57,370	63,040																					
	R/L 152S-4032 × 30 × 10/190-300		57,370	63,040																					
	R/L 152S-4032 × 30 × 10/300-∞		57,370	63,040																					
¹⁾ R/L 152S-4032 × 50 × 10/140-190		67,870	74,630	40	32	200	50	10-11	140-190	SHN 10T	F6S-518T	BF 05T	NY 3												
¹⁾ R/L 152S-4032 × 50 × 10/190-300		67,870	74,630																						
¹⁾ R/L 152S-4032 × 50 × 10/300-∞		67,870	74,630																						
12	R/L 152S-4032 × 30 × 12/75-100		57,370	63,040	40	32	200	30	12	75-100	SHR 3012MT	SHL 3012MT	F6S-519	BF 05M	NY 3										
	R/L 152S-4032 × 30 × 12/100-140		57,370	63,040																					
	R/L 152S-4032 × 30 × 12/140-190		57,370	63,040																					
	R/L 152S-4032 × 30 × 12/190-300		57,370	63,040																					
	R/L 152S-4032 × 30 × 12/300-∞		57,370	63,040																					
	R/L 152S-4032 × 40 × 12/75-100		64,130	70,520	40	32	200	40	12	75-100	SHR 4012MT	SHL 4012MT	F6S-526	BF 05M	NY 3										
	R/L 152S-4032 × 40 × 12/100-140		64,130	70,520																					
	¹⁾ R/L 152S-4032 × 50 × 12/140-190		67,870	74,630																					
	¹⁾ R/L 152S-4032 × 50 × 12/190-300		67,870	74,630																					
¹⁾ R/L 152S-4032 × 50 × 12/300-∞		67,870	74,630	40	32	200	50	12	140-190	SHN 12T	F6S-519	BF 05T	NY 3												
¹⁾ R/L 152S-5040 × 50 × 12/140-190	都度見積り	都度見積り																							
¹⁾ R/L 152S-5040 × 50 × 12/190-300	都度見積り	都度見積り																							
¹⁾ R/L 152S-5040 × 50 × 12/300-∞	都度見積り	都度見積り																							

注文例：R152S-2020 × 12 × 4/50-60...2本

◎：左右両勝手在庫 ○：右勝手のみ在庫 空欄：メーカー（海外）または受注生産

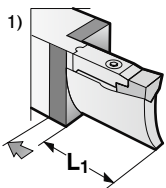

1) ホルダを修正することにより、より深い切込が可能です。

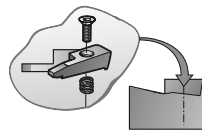

レンチ以外のパーツはホルダに付属しています。